

RunSAP



An Introduction to SAP Technology

Yao Wang
SAP America Inc

SAP is the largest and most recognized Fortune 1000, Global 5000 and enterprise market share leader. The company has achieved its success due to its extremely deep accounting and distribution software suites along with tightly integrated financials, manufacturing, human resource, payroll and customer relationship management software systems. – ERP Software 360

Content



Overview

Navigation Demo

The System Core

Main Products

Software Development, Deployment, and Lifecycle

Business Process and Data Management

System Administration

Learning and Job Market

Q & A

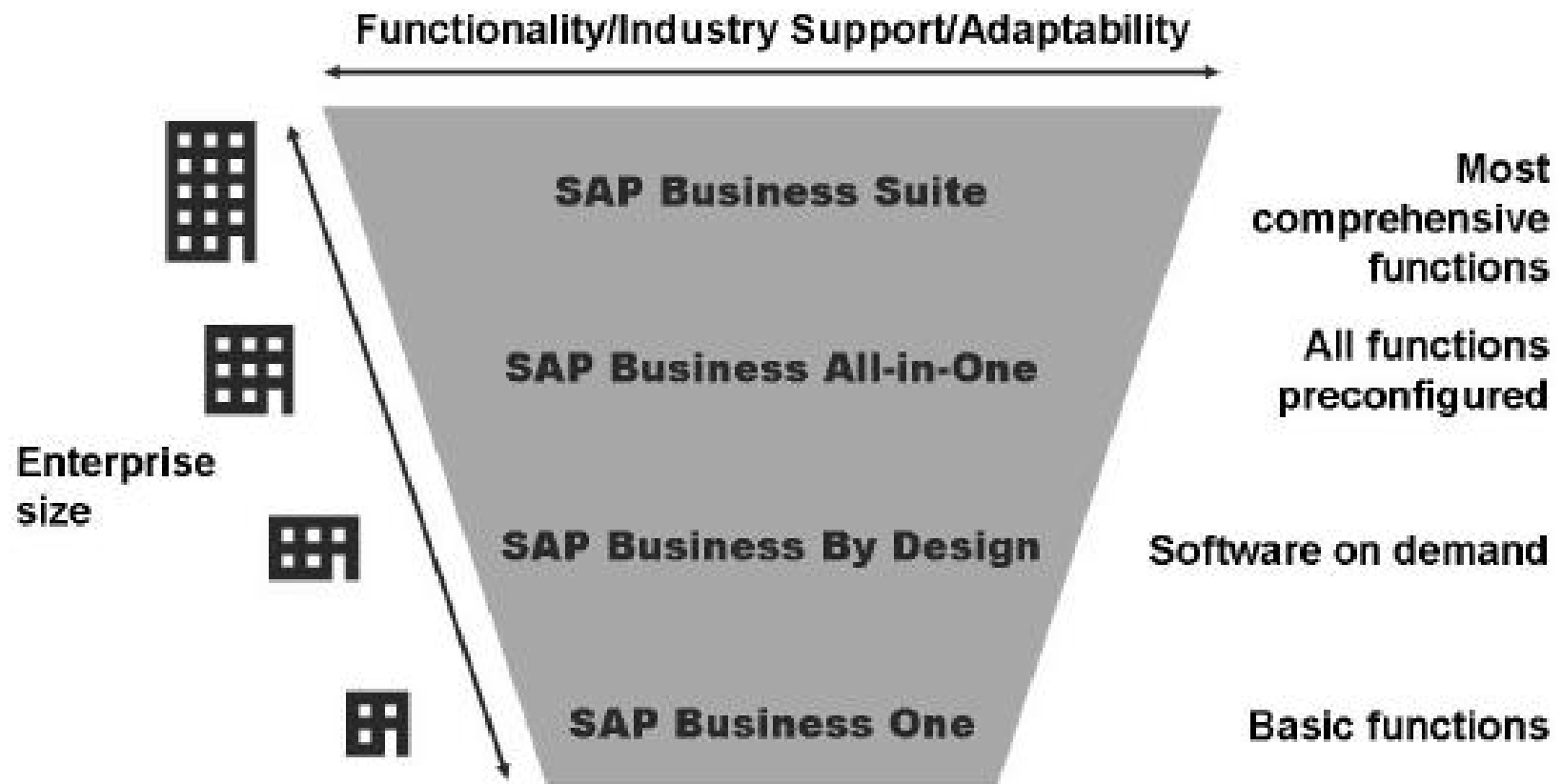
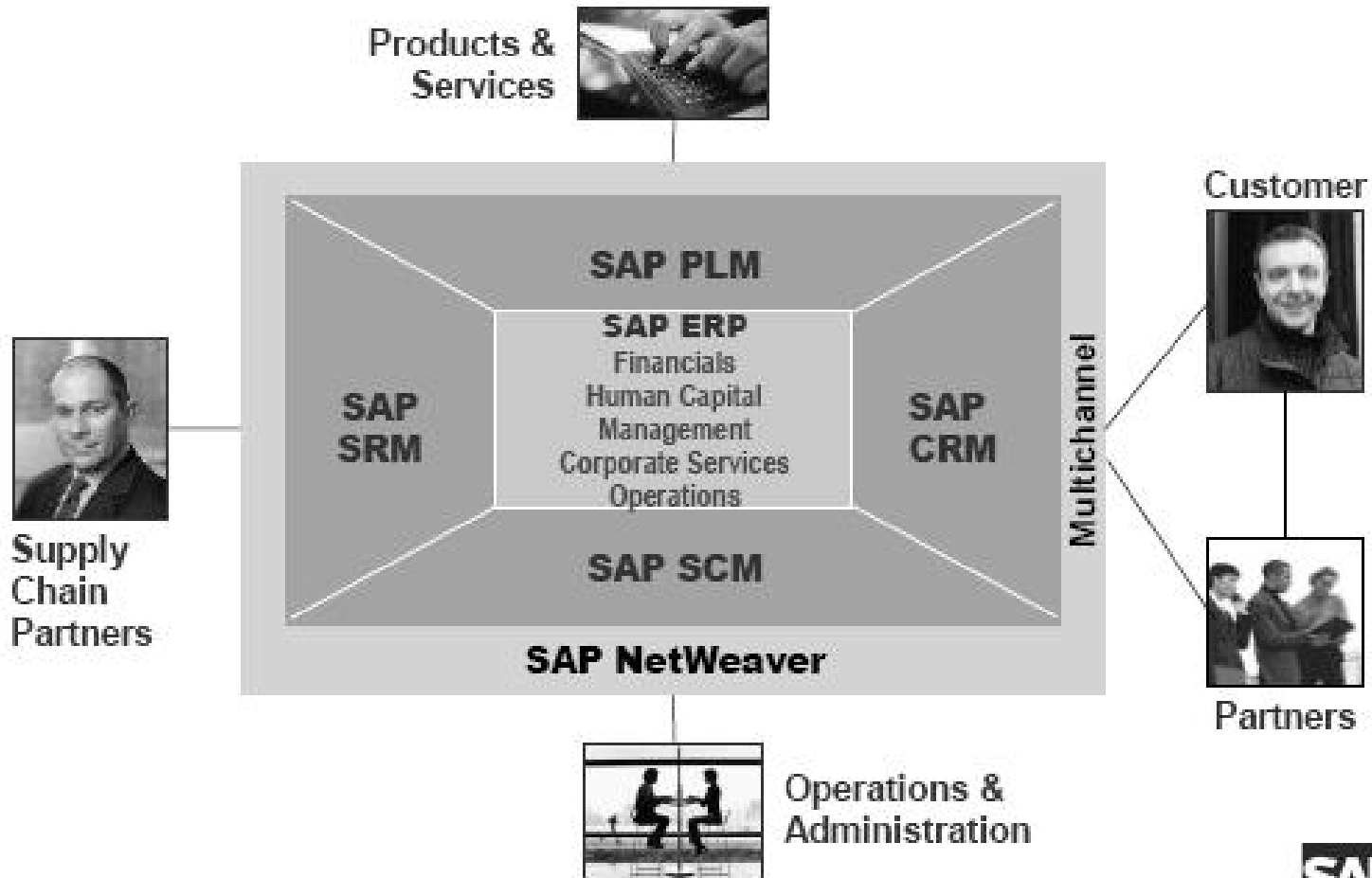

Figure 1: Different Sizes - Different Products

Overview



SAP Business Suite and the Corporate Business Environment



SAP Industrial Area



Automobile industry

Construction industry, engineering,

High tech and electronics industry

Consumer products industry

Aerospace and space industry

Mechanical engineering

Metal, wood and paper industry

Mining

Chemicals

Life sciences

Oil and gas industry

Bank

Healthcare

Universities and research institutes

Internal & external security

Public sector

Insurance

Service industry

Wholesale

Retail

Logistics service providers

Media industry

Telecommunications

Utilities industry

Content



Overview

Navigation Demo

The System Core

Main Products

Software Development, Deployment, and Lifecycle

Business Process and Data Management

System Administration

Learning and Job Market

Q & A

Content



Overview

Navigation Demo

The System Core

Main Products

Software Development, Deployment, and Lifecycle

Business Process and Data Management

System Administration

Learning and Job Market

Q & A

SAP Core Technology

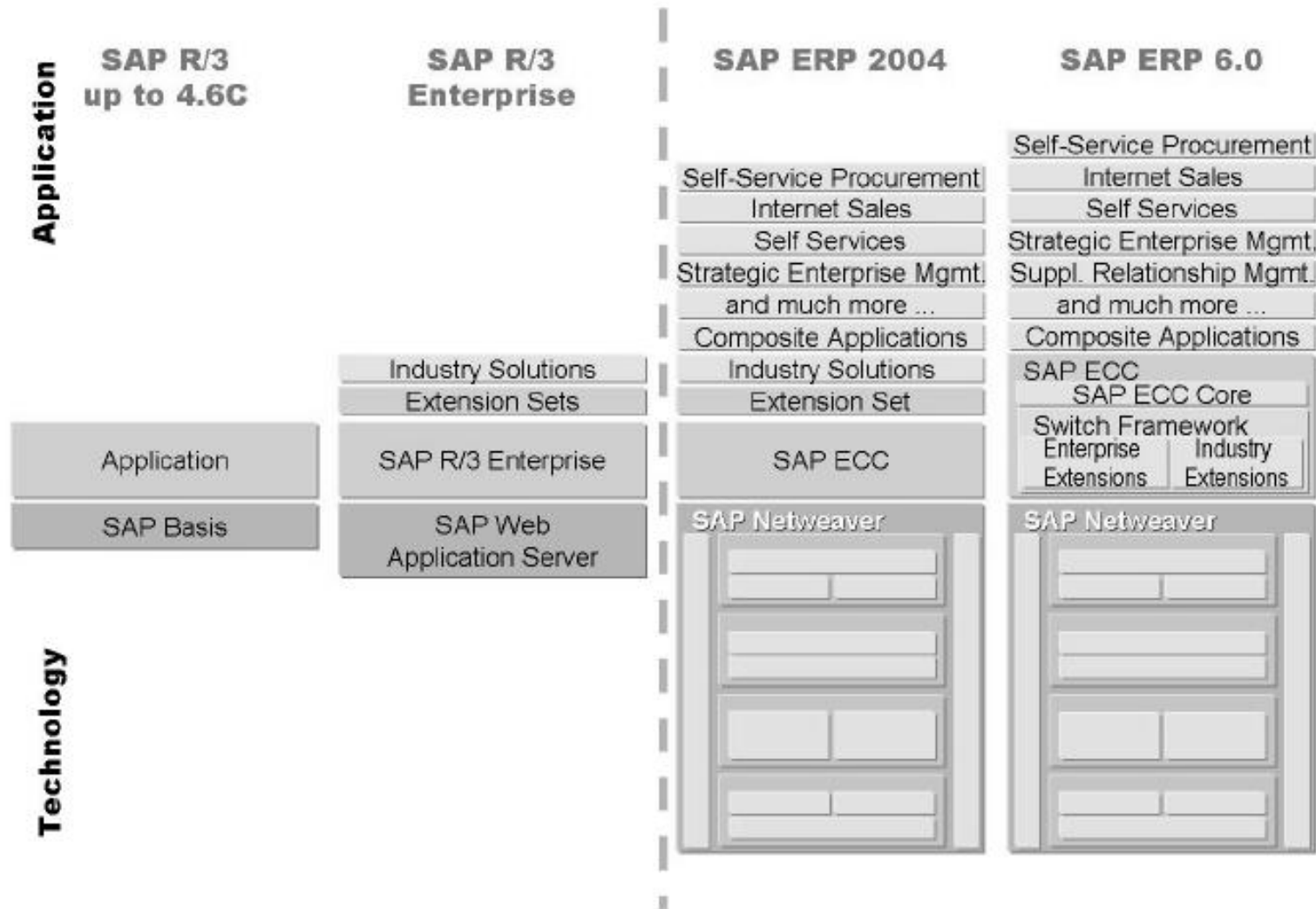



SAP NetWeaver Layers

- **Integration of people, information and processes**
 - Across technological and organizational boundaries
 - .NET and WebSphere interoperability
- **The technological foundation for SAP customers and partners**
 - Solutions with lower total cost of ownership (TCO)
 - The Enterprise Services Architecture (ESA) increases the flexibility and extendibility of business processes

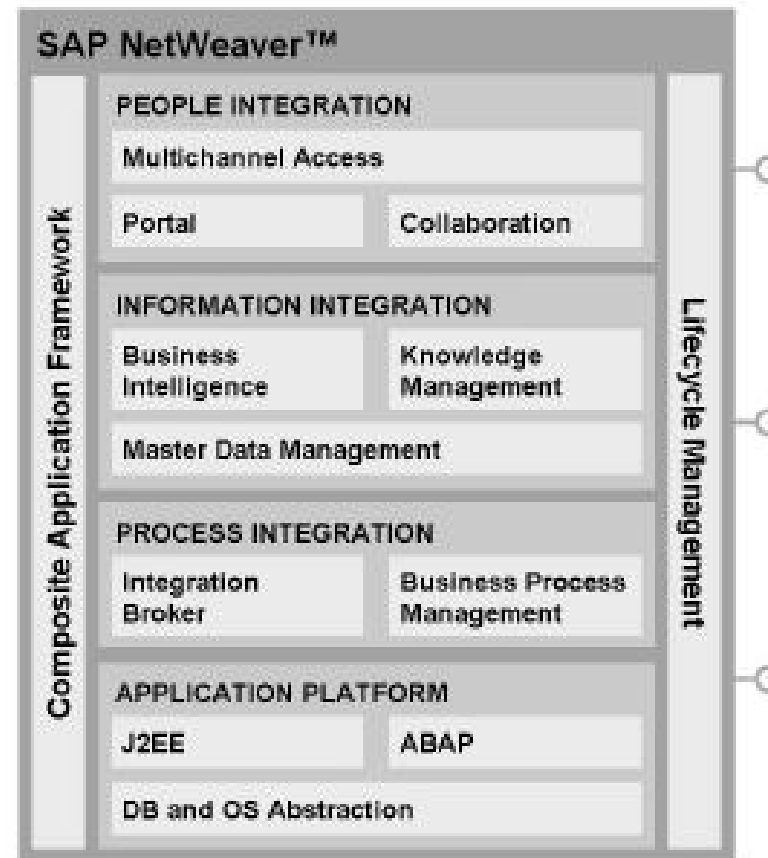

SAP Core Technology



AS ABAP System



AS Java System

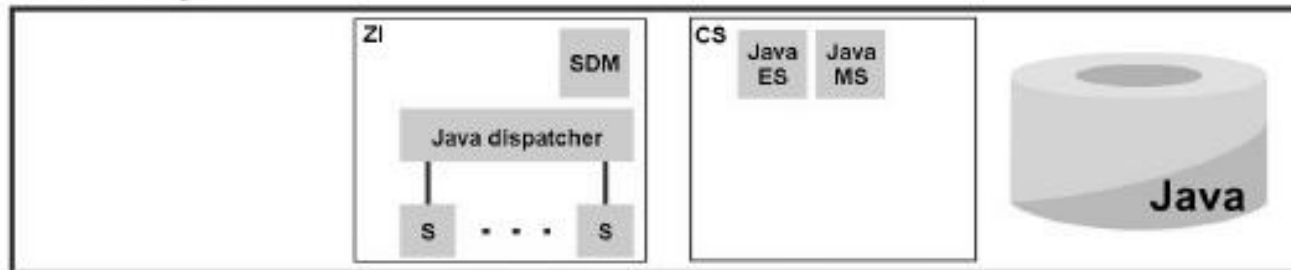

AS ABAP + Java System

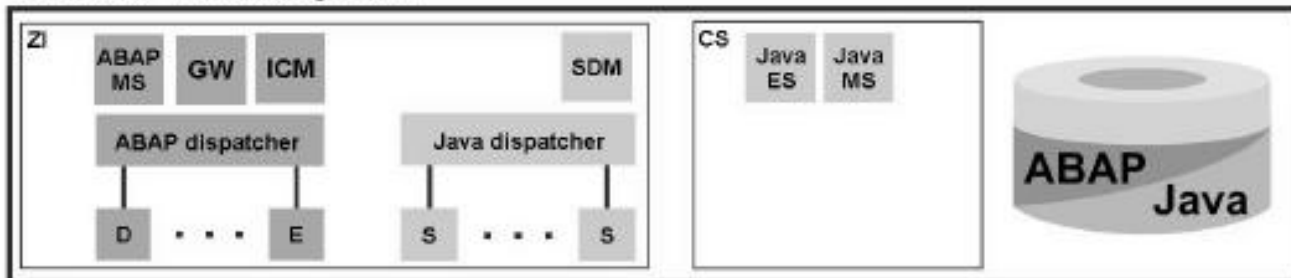
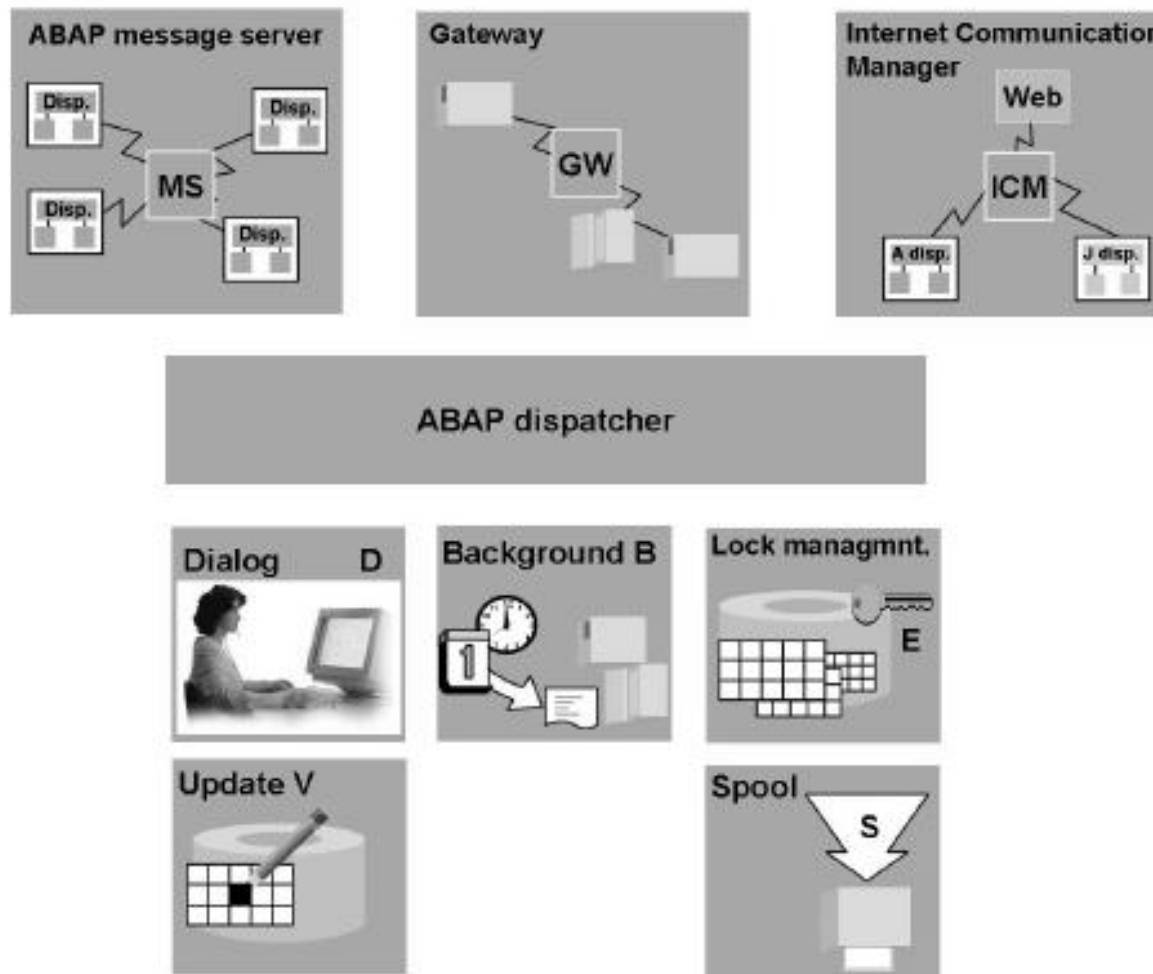

Figure 32: Possible Types of SAP NetWeaver AS

SAP Core Technology



AS ABAP Processes



SAP Core Technology



AS Java Processes

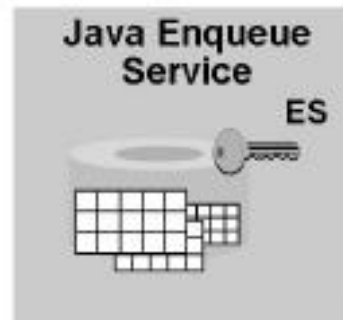
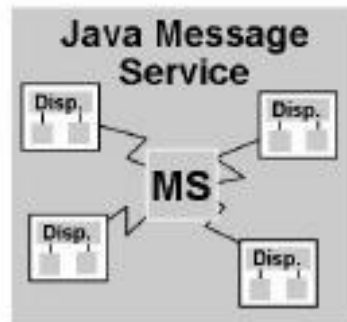

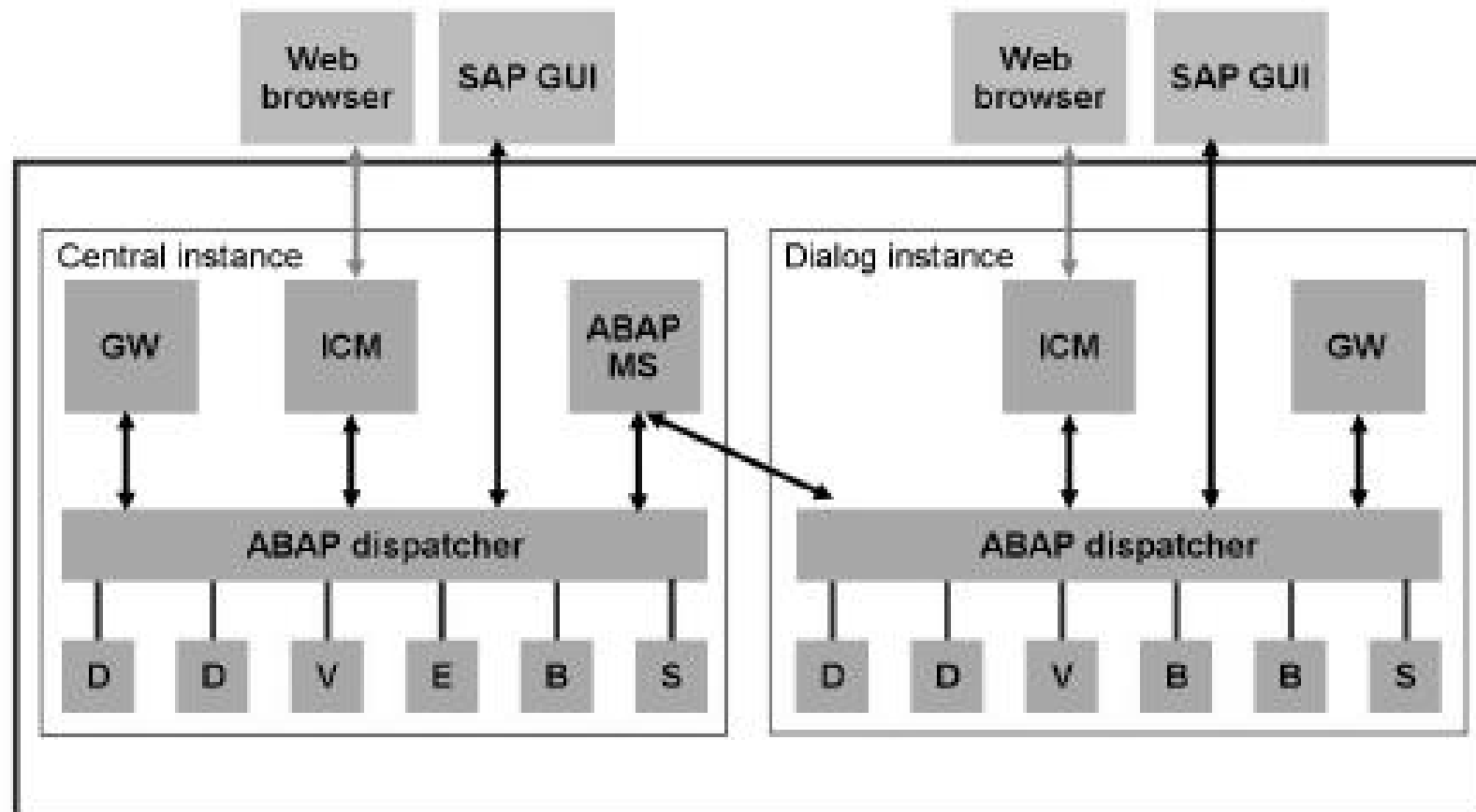

Figure 33: AS ABAP Architecture

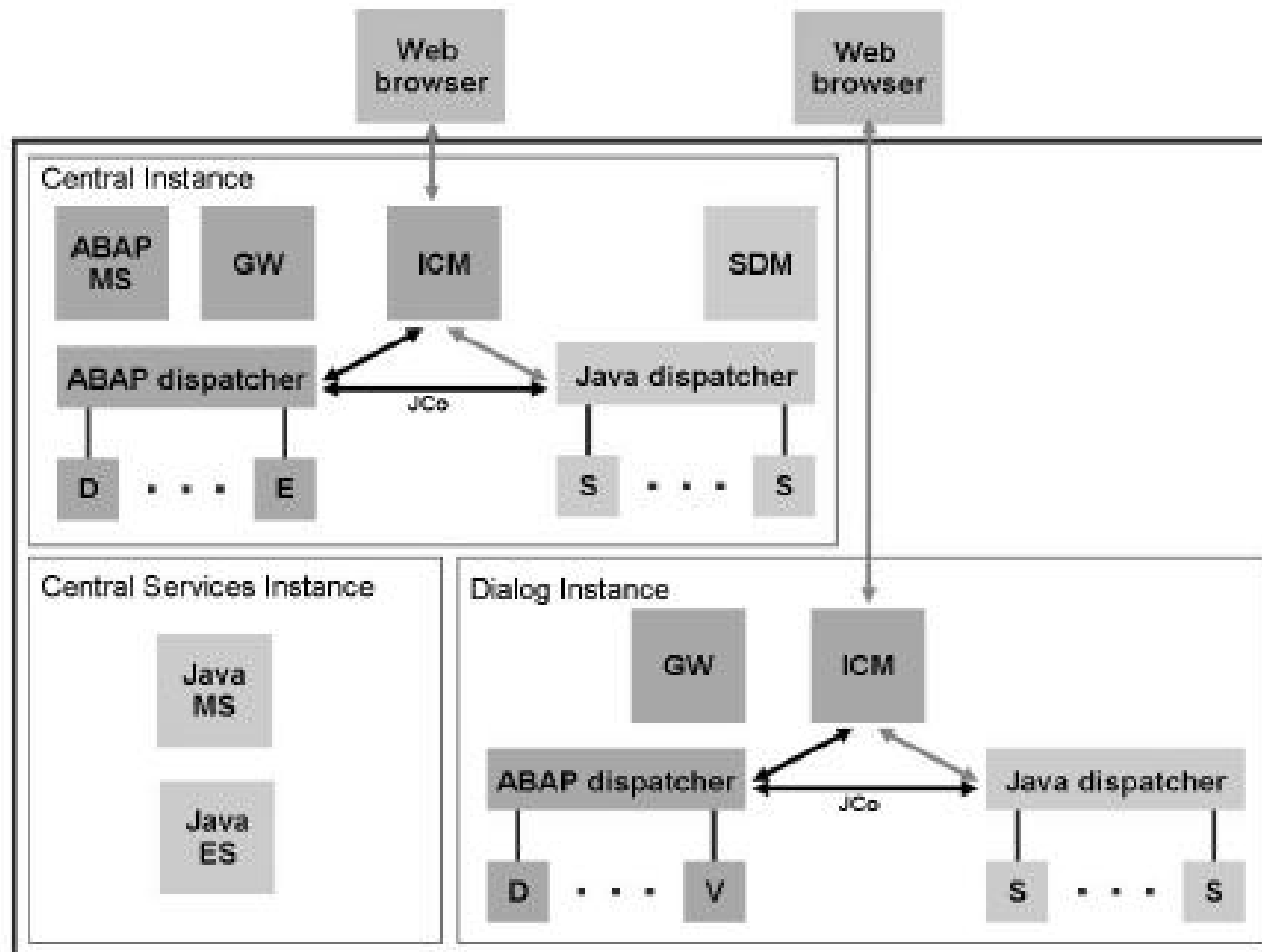

Figure 35: AS ABAP+Java Architecture

SAP Core Technology

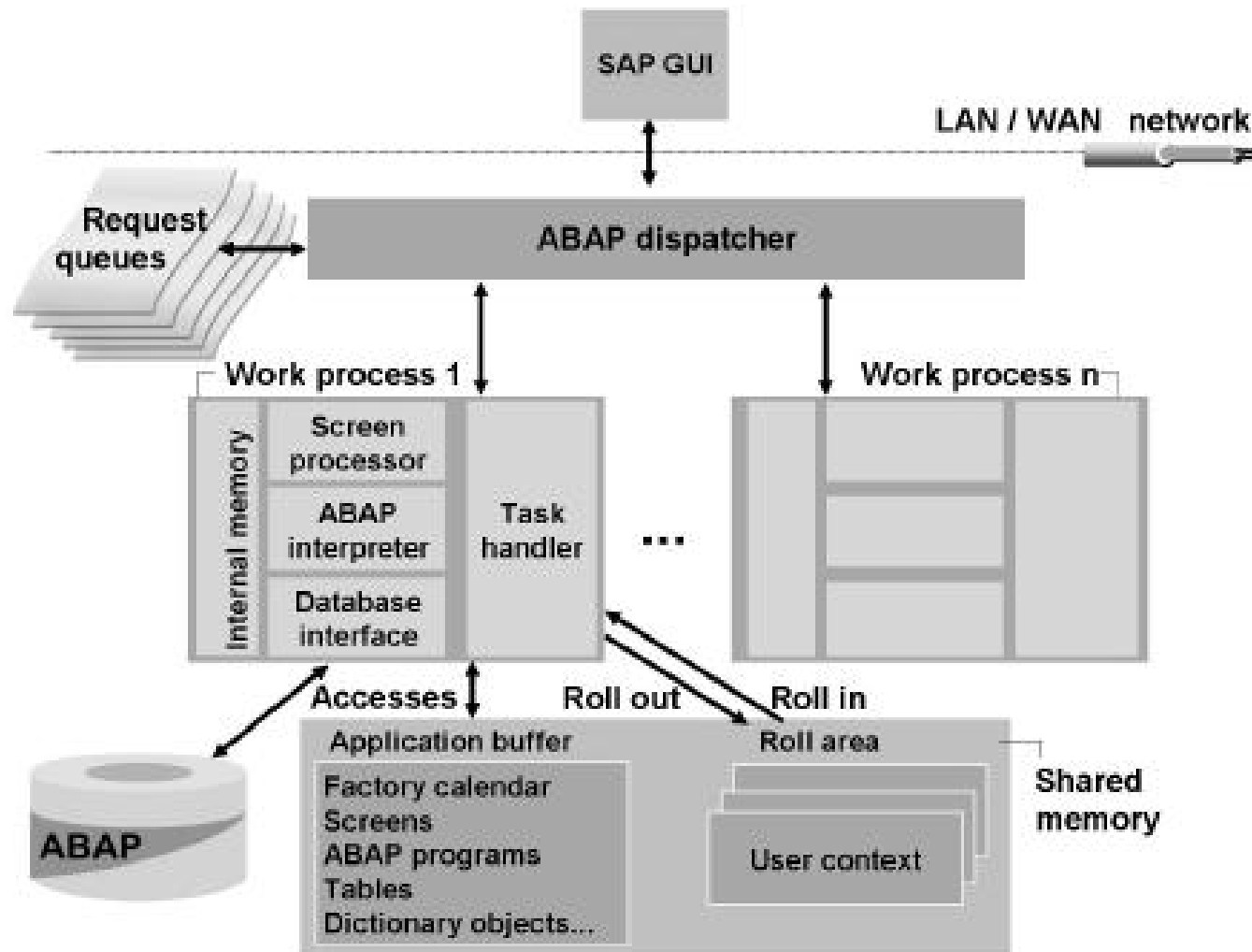

Figure 37: Process Flow for Requests

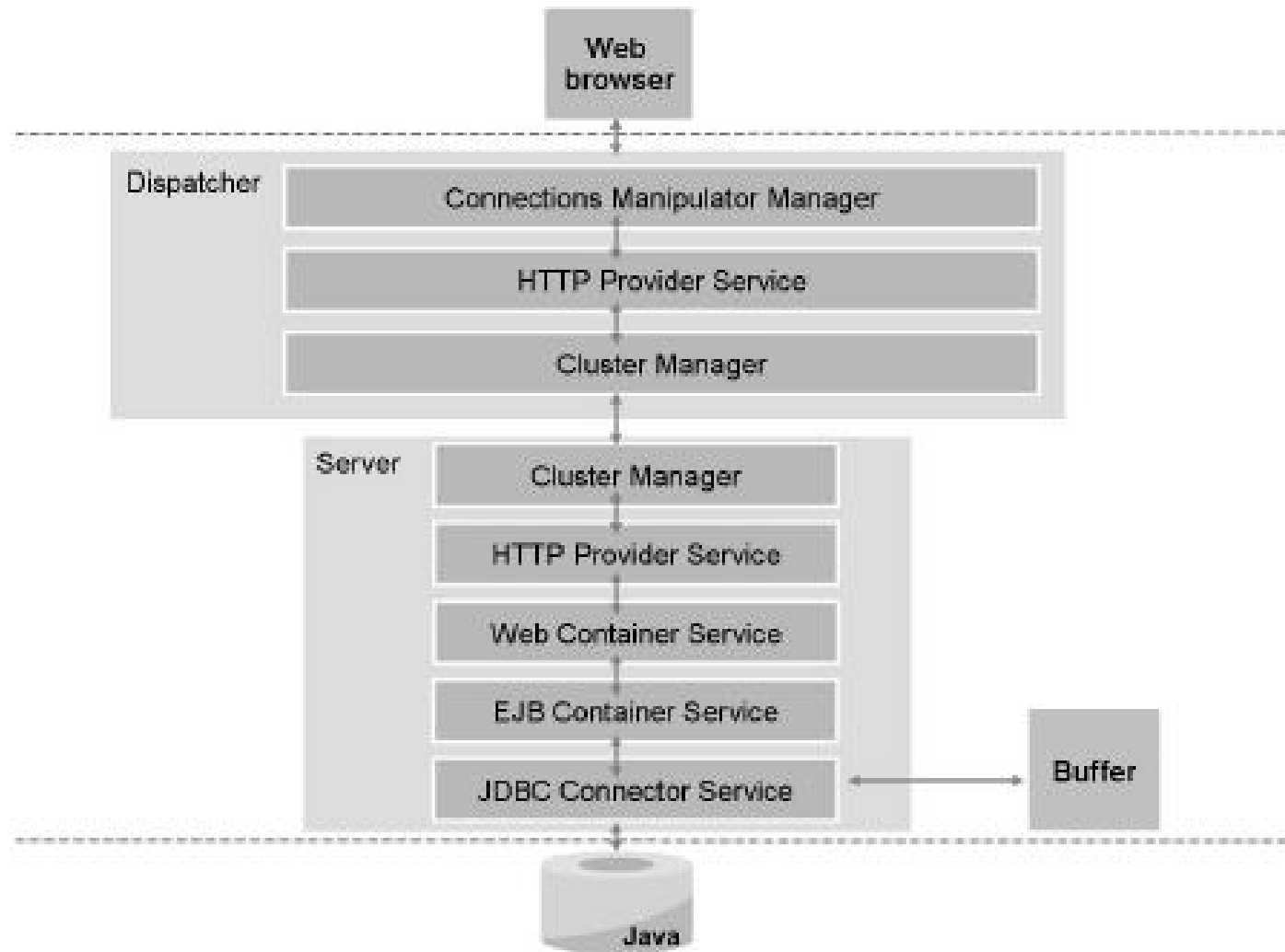

Figure 49: Processing a Request

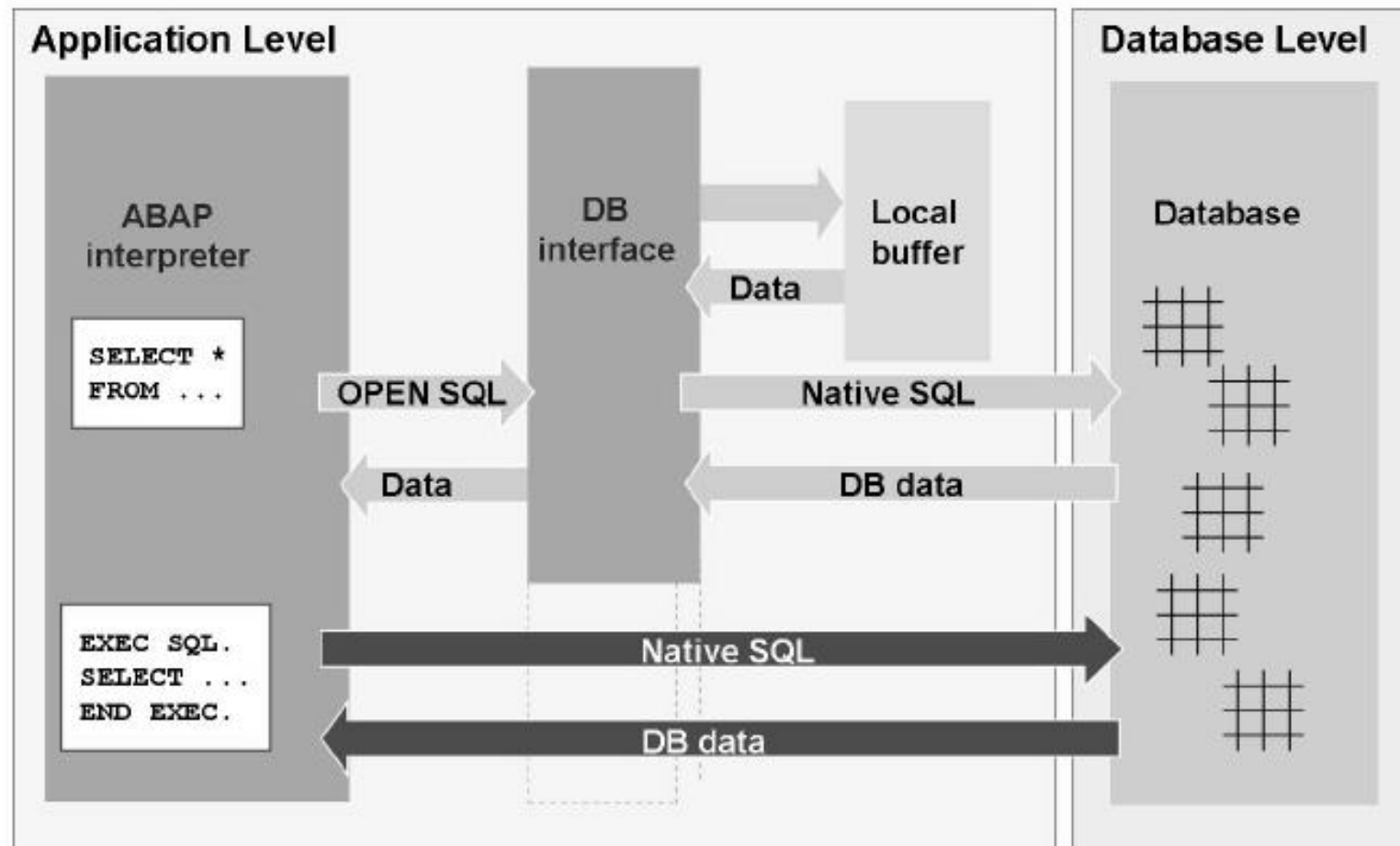

Figure 38: Database Query Flow

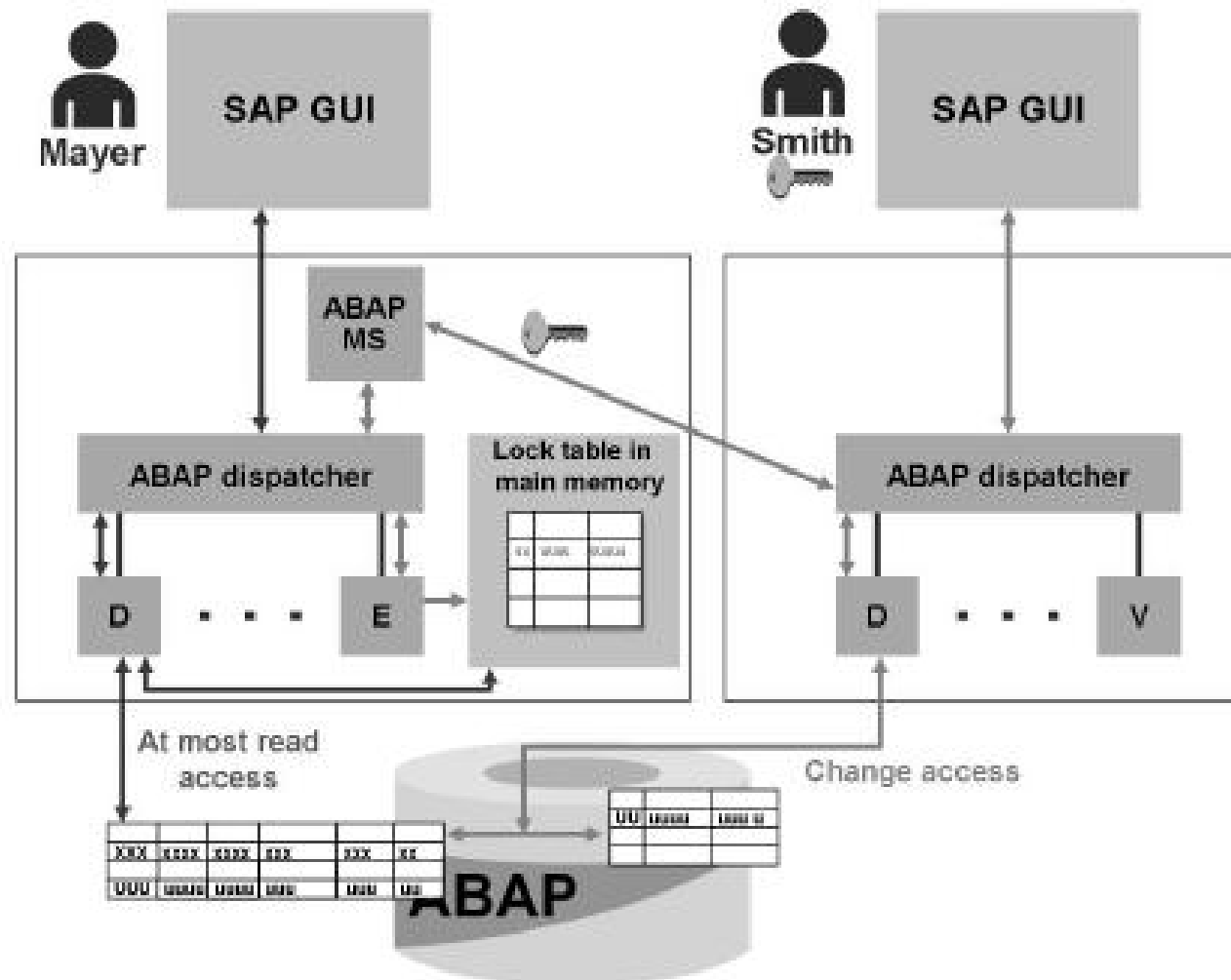

Figure 41: Lock Management in AS ABAP

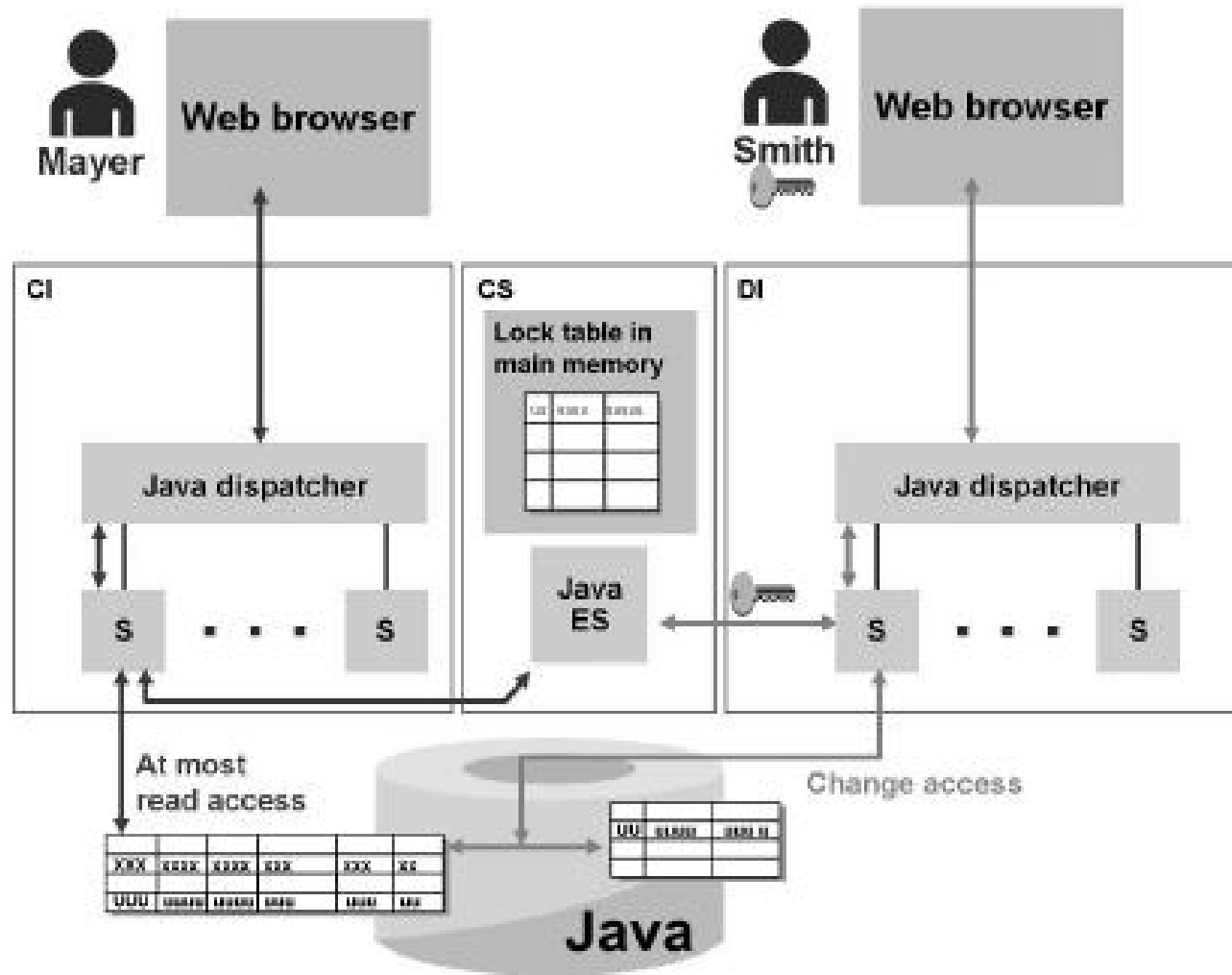

Figure 52: Lock Management in AS Java

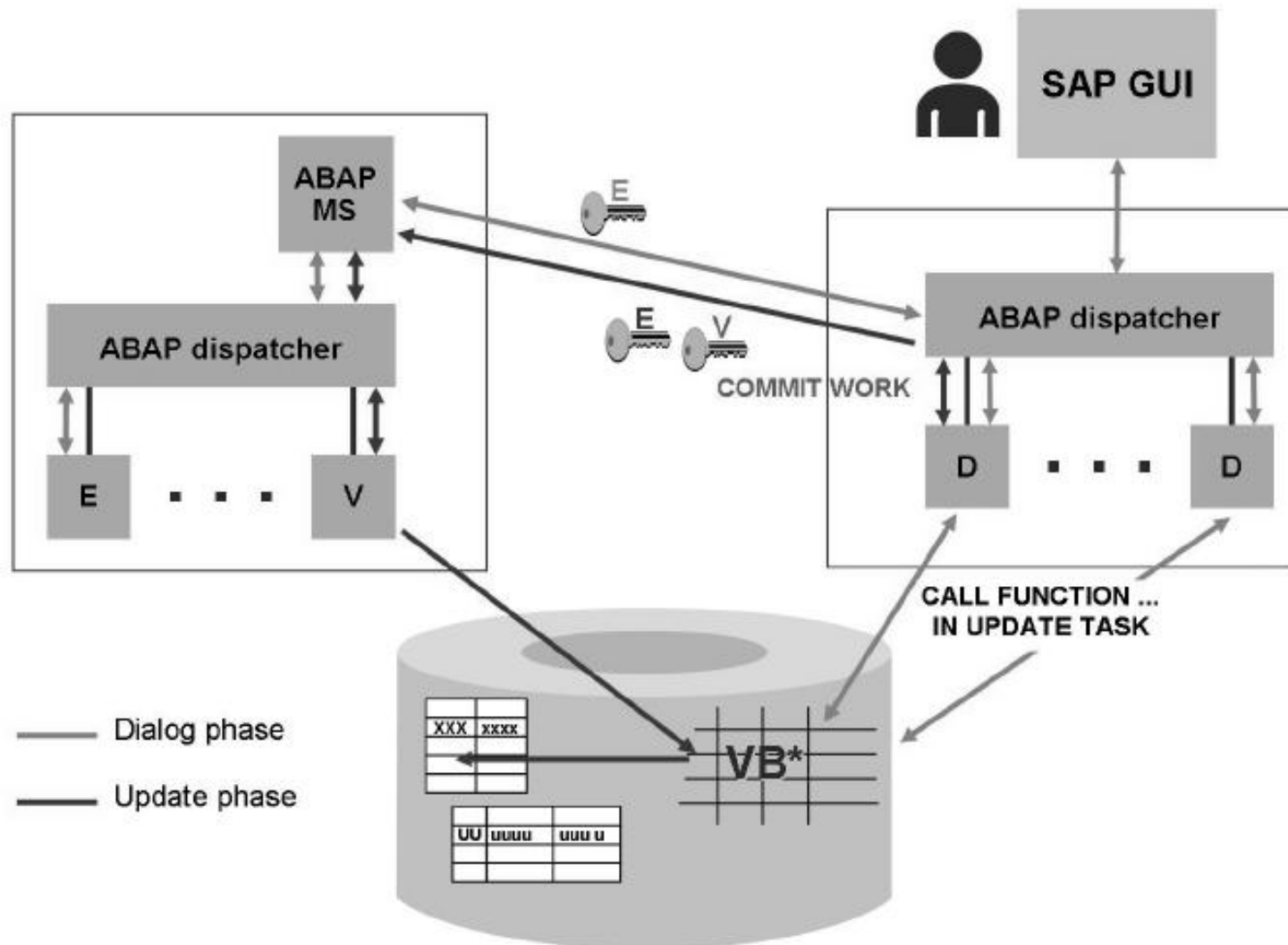

Figure 43: The Asynchronous Update Process

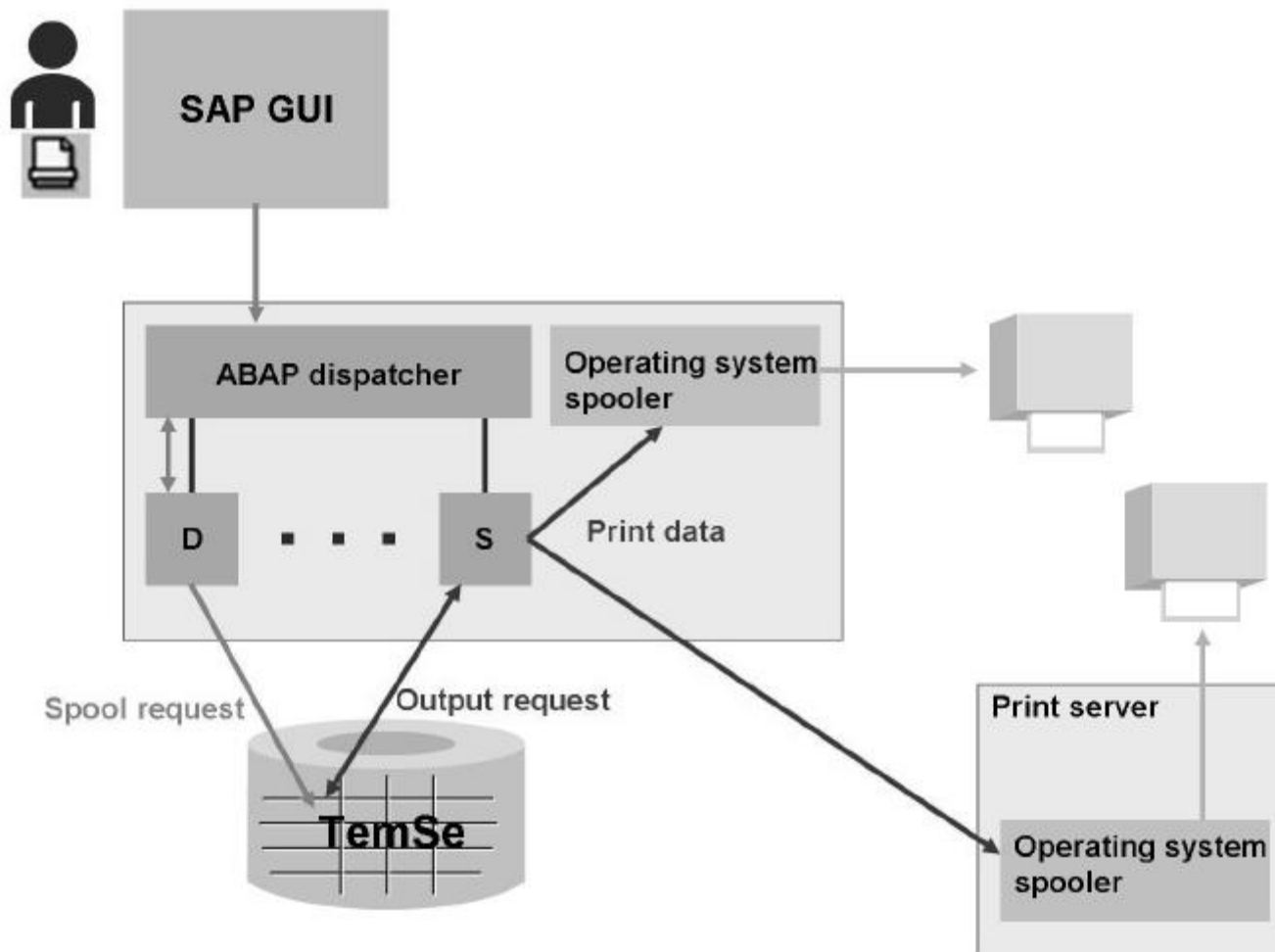

Figure 44: Printing in AS ABAP

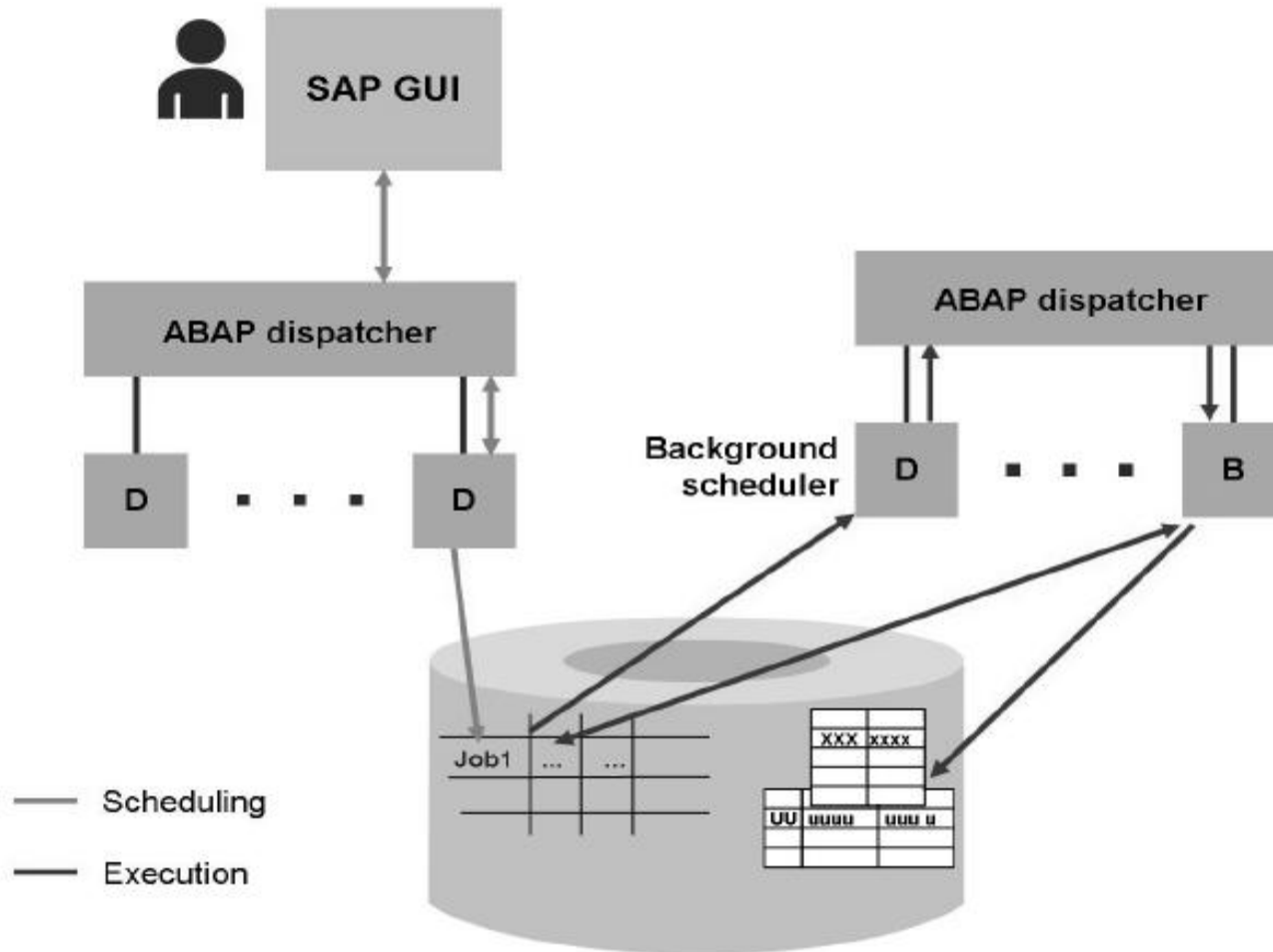

Figure 45: Scheduling Background Tasks (Jobs)

SAP Core Technology

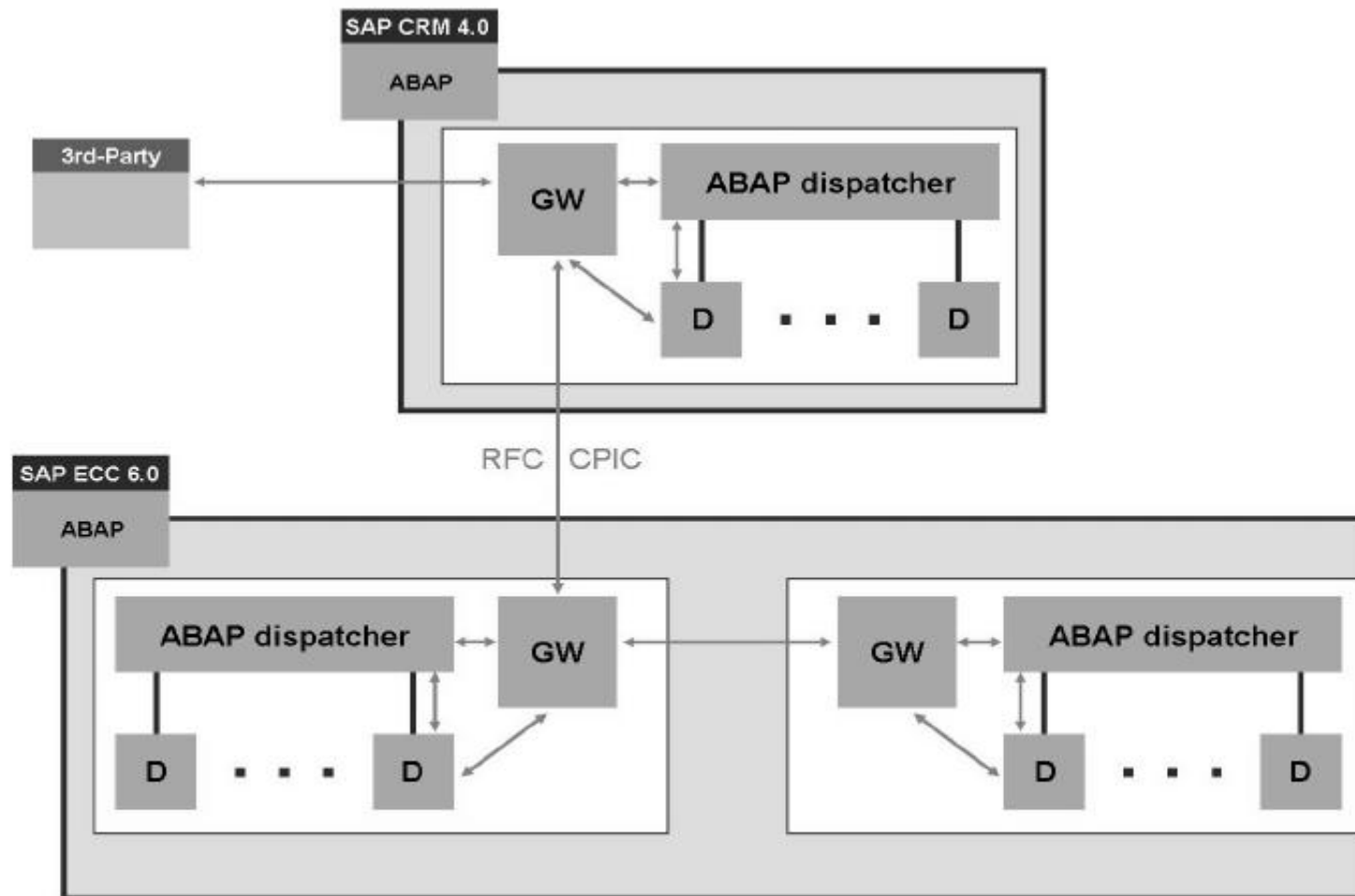

Figure 46: Gateway Communication

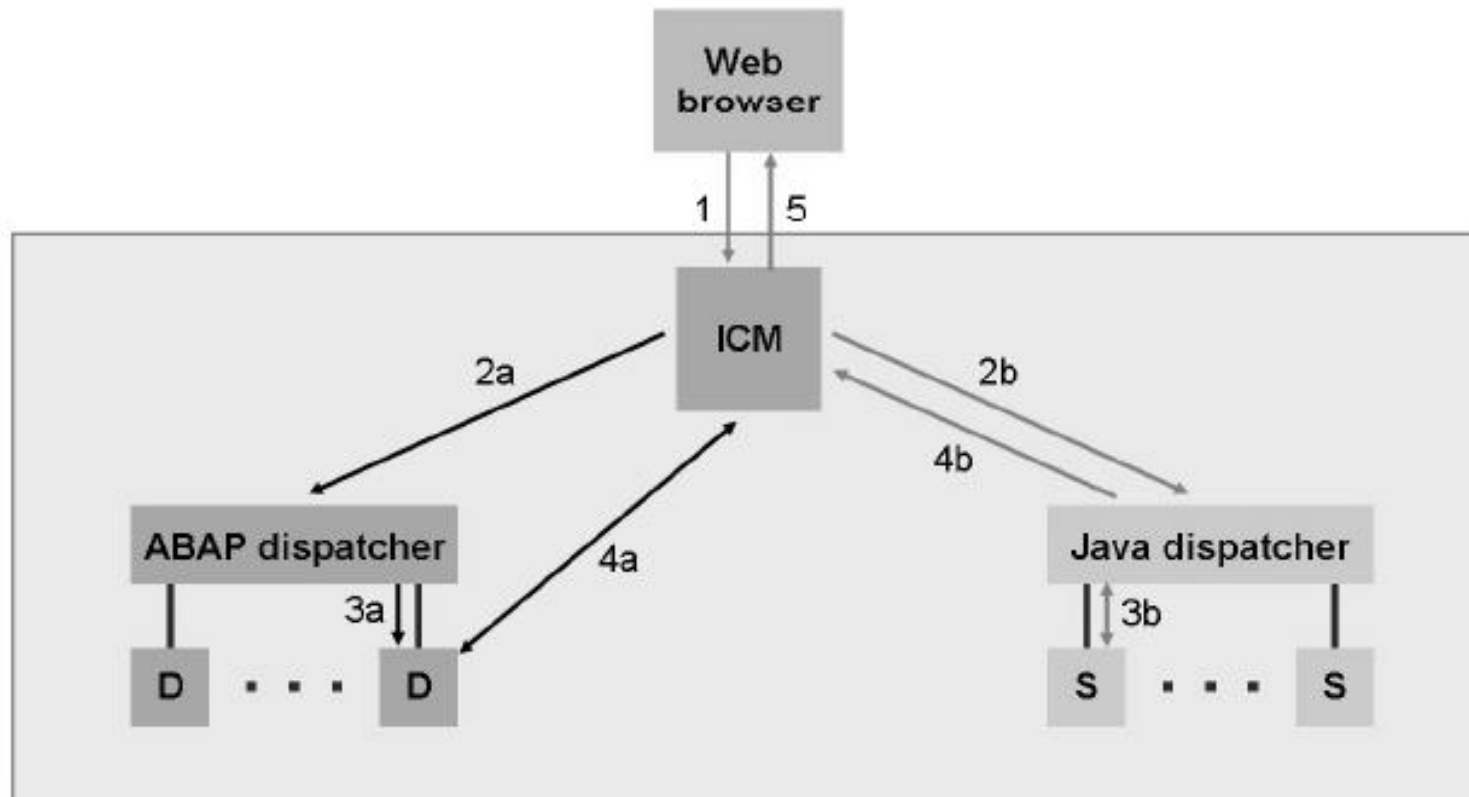

Figure 47: Processing a Web Request

Content



Overview

Navigation Demo

The System Core

Main Products

Software Development, Deployment, and Lifecycle

Business Process and Data Management

System Administration

Learning and Job Market

Q & A



SAP ERP Solution Map

Strategic Enterprise Management	Stakeholder Relationship Management	Strategy Management	Performance Measurement	Strategic Planning & Simulation	Business Consolidation	
Business Analytics	Financial Analytics	Customer Relationship Analytics	Supply Chain Analytics	Human Resource Analytics	Product Lifecycle Analytics	
Accounting	Financial Statements	General Ledger & Subledgers	Revenue & Cost Accounting	Order & Project Accounting	Product & Service Cost Calculation	
Financial Supply Chain Management	Credit Management	Electronic Bill Presentment and Payment	Dispute Management	In-House Cash	Cash & Liquidity Management	Treasury & Risk Management
Corporate Services	Real Estate Management		Travel Management		Incentive & Commission Management	
Financial Portal Solutions	Manager Self-Service			Corporate Finance Portal		

SAP ERP Financial

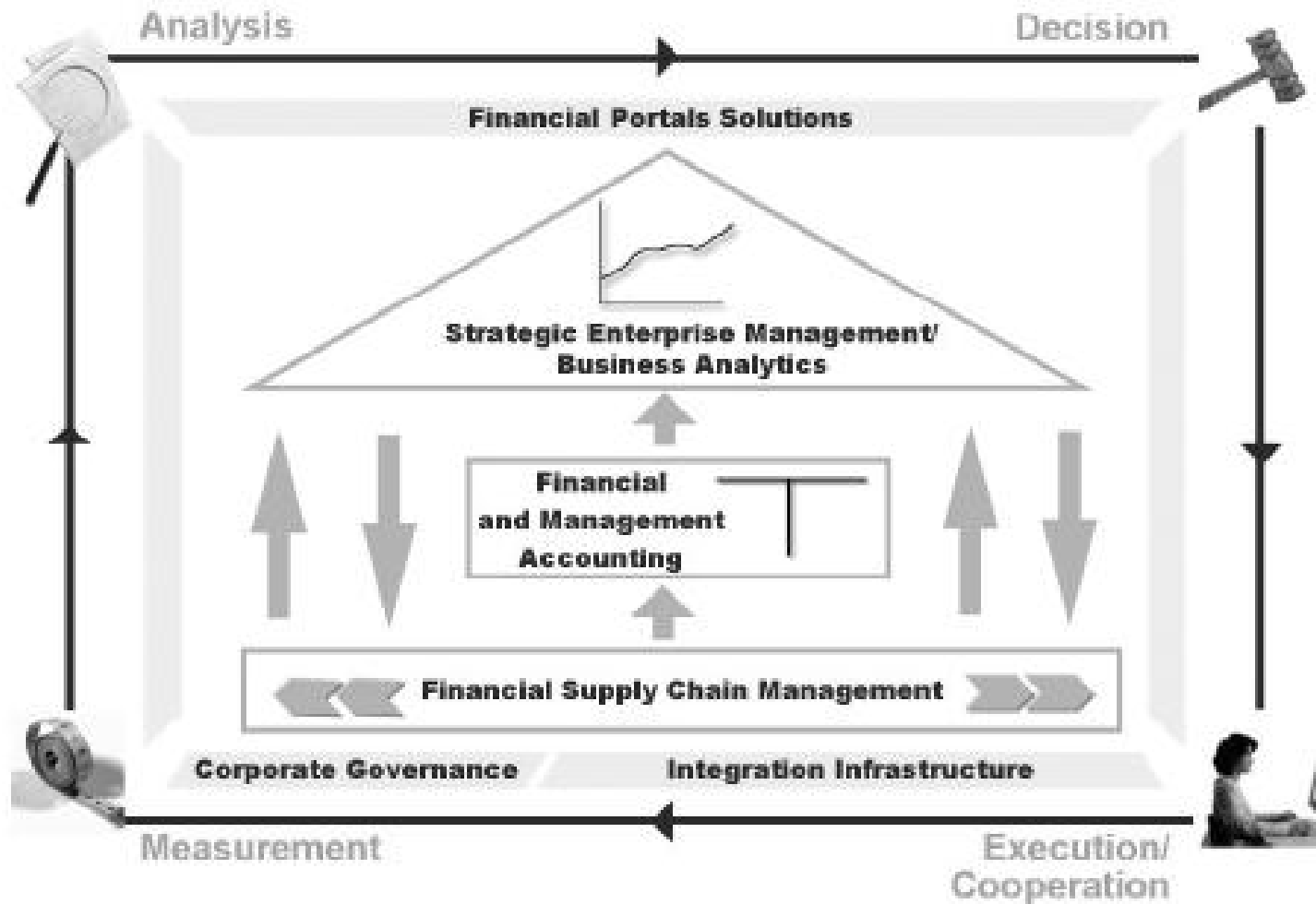



The diagram illustrates the relationship between three levels of SAP HCM structure: Enterprise structure, Personnel structure, and Organizational structure. A globe in the background represents the enterprise level, a group of people represents the personnel level, and a hierarchy of boxes represents the organizational level.

Personnel data		Enterprise structure	
Personnelno.	1001	Name	Michaela Maier
EE Group	1 Act. Employee	PersArea	1300 Frankfurt
EESubgroup	DU Salaried EE	Cost Center	2100 Finance and Admin
From	01.01.1994	To	31.12.9999
		Chng.	28.01.1998
			BILLE

Enterprise structure		Personnel structure	
CoCode	1000 IDES	EE Group	1 Active EE
Pers. Area	1300 Frankfurt	EESubgroup	DU Salaried EE
Cost Ctr	2100	Payr. Area	D2 HR-D: Salaried EE
		Contract Data	Com. Employee
		Legal Person	0001
		Subarea	Headquarters
		Bus. Area	9900 Corporate Other

Organization plan		Administrator	
Percentage	100.00	Group	1300
Position	50000075 Functional Specialist Func. Spec - D	PersAdmin	001 Helmut Hesse
Job Key	50011880 Administrator Admin.	Time	002 Dagmar Krause
Org. Unit	50000073 Travel Expenses (D) Trav. Exp.	Payroll	003 Oliver Zeuner
Org. Key	1300 -D	Supervisor	

Figure 14: Organizational, Enterprise, and Personnel Structure

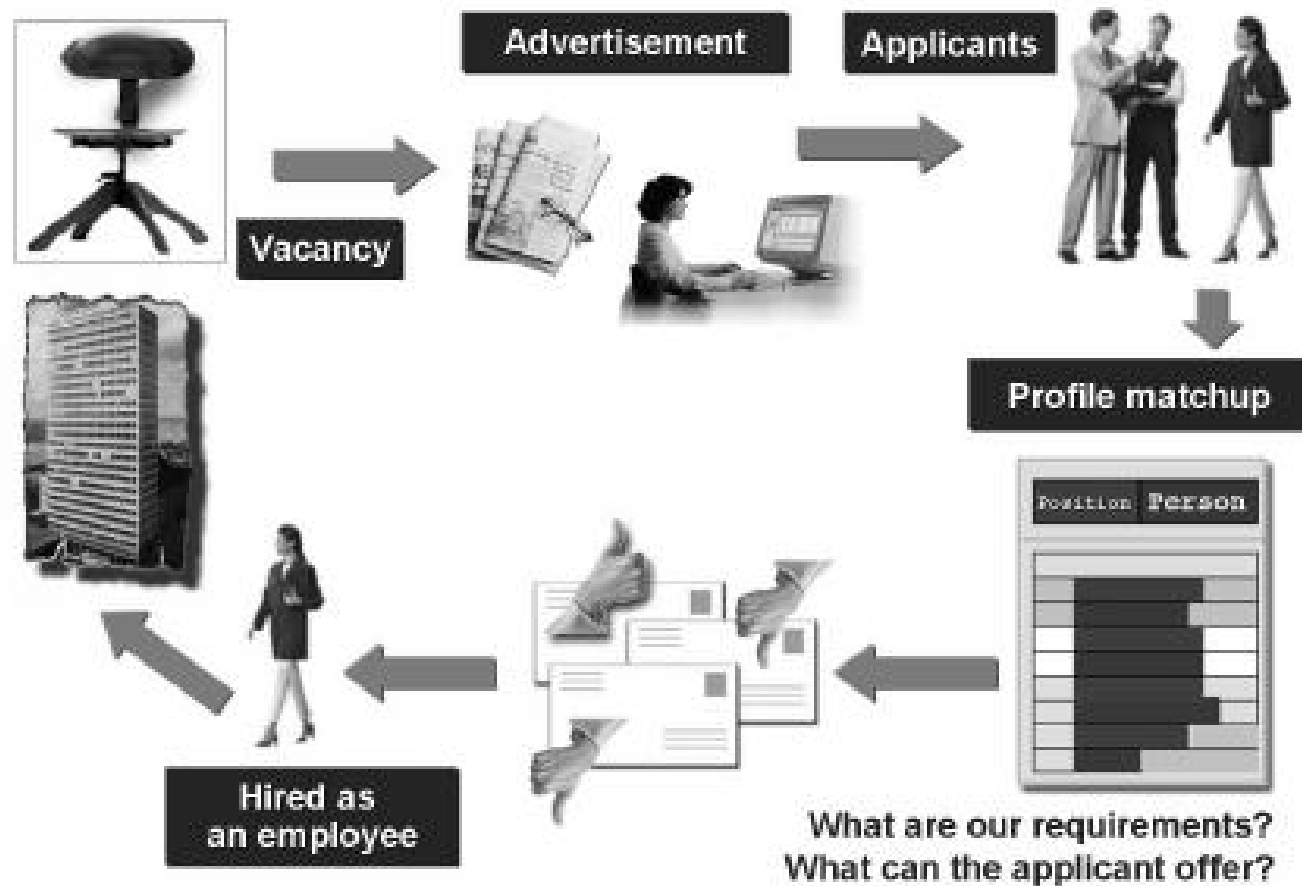

Figure 43: From the Vacancy to the Hiring



EMPLOYEE SERVICES

EMPOWERING EMPLOYEES



Me at SAP

- [Time & Vacation](#)
- [Life & Work Events](#)
- [Personal Data](#)
- [Benefits & Health](#)
- [Compensation & Equity](#)
- [Career Success Center](#)
- [Global Mobility](#)
- [Diversity](#)
- [Recognition](#)
- [Employee Relations & Representatives](#)
- [More Services](#)



Order & Purchasing

- [Overview](#)
- [Goods & Services](#)
- [Policies & Guidelines](#)



IT Services

- [Support & Requests](#)
- [Hardware & Software](#)
- [Conferencing](#)
- [Connecting to SAP](#)
- [E-mail](#)
- [Telecommunications](#)
- [Guest at SAP](#)
- [Business Objects Integration](#)



Travel

- [Policies](#)
- [Planning](#)
- [Expenses](#)
- [Ground Transportation](#)
- [Programs](#)
- [Services](#)
- [Risks](#)



Security

- [Security@SAP](#)
- [Customer & Product Security](#)
- [IT & Information Security](#)
- [Emergencies](#)
- [Travel Risks](#)
- [Security Made Easy](#)
- [Contacts](#)



Support

- [IT Support](#)
- [IT Services](#)
- [Security](#)
- [Facility Services](#)
- [Facility Support](#)
- [HRdirect](#)
- [Change Management](#)

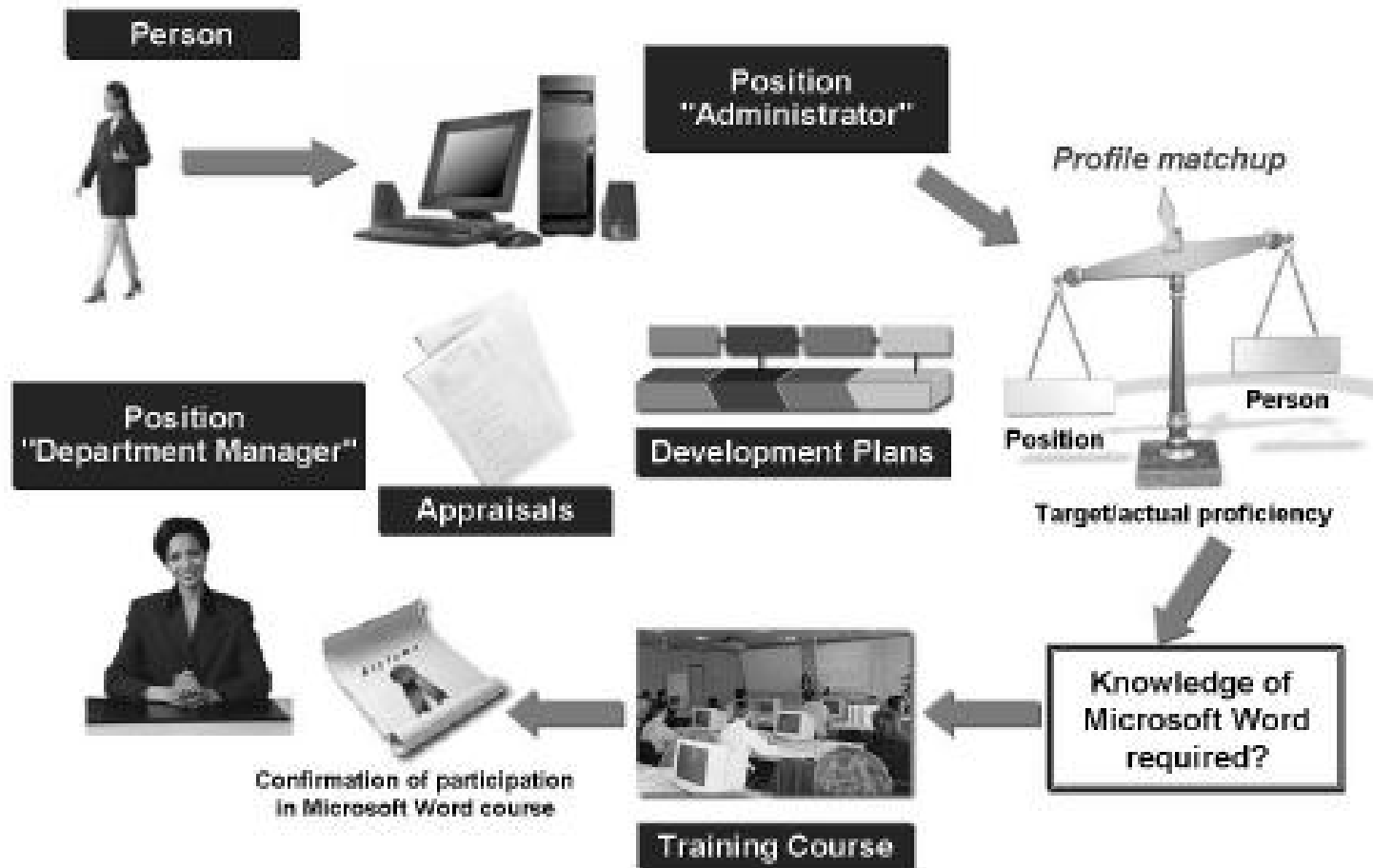

Figure 95: Personnel Development and Qualifying Actions

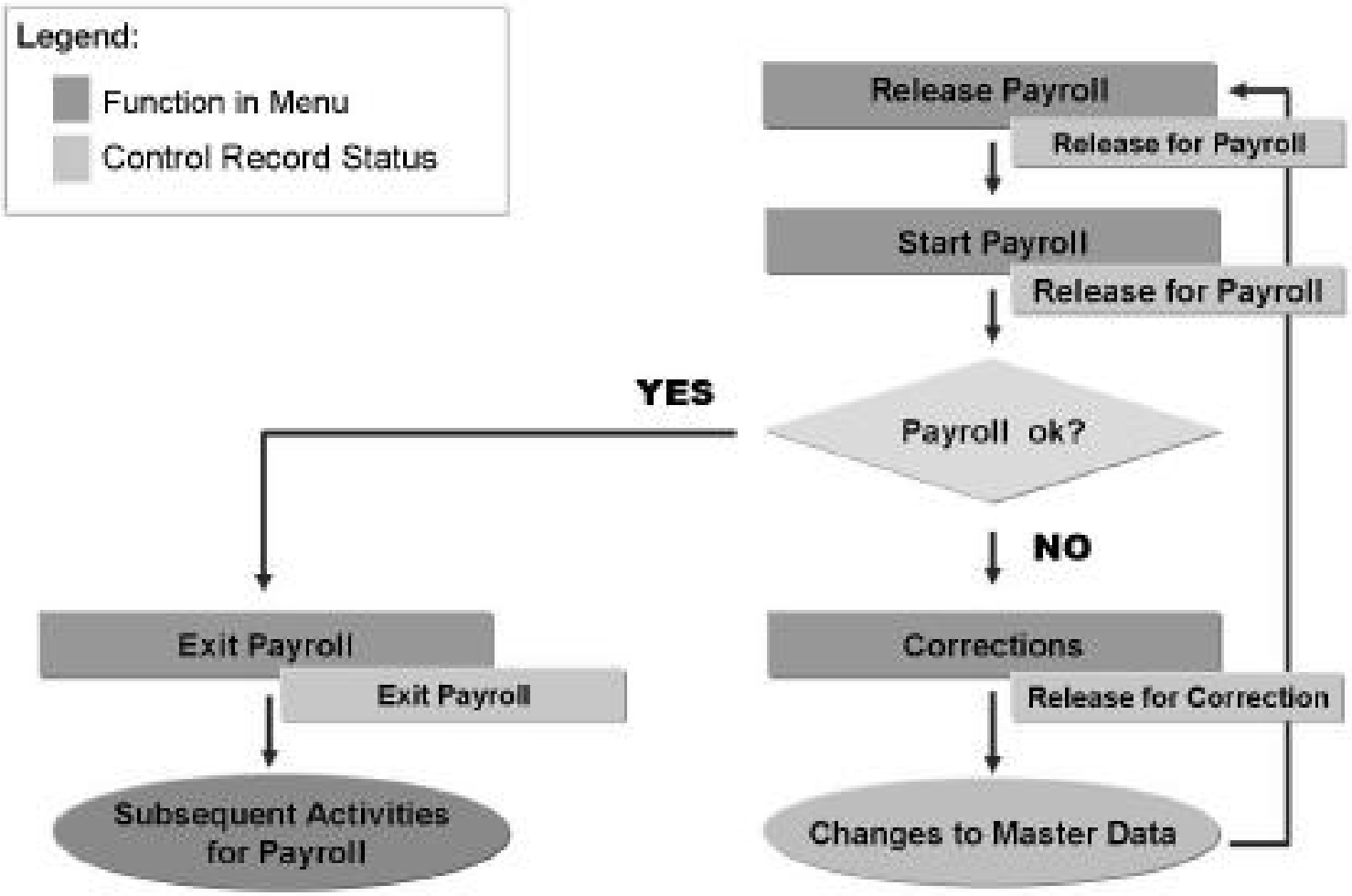

Figure 125: Payroll Administration

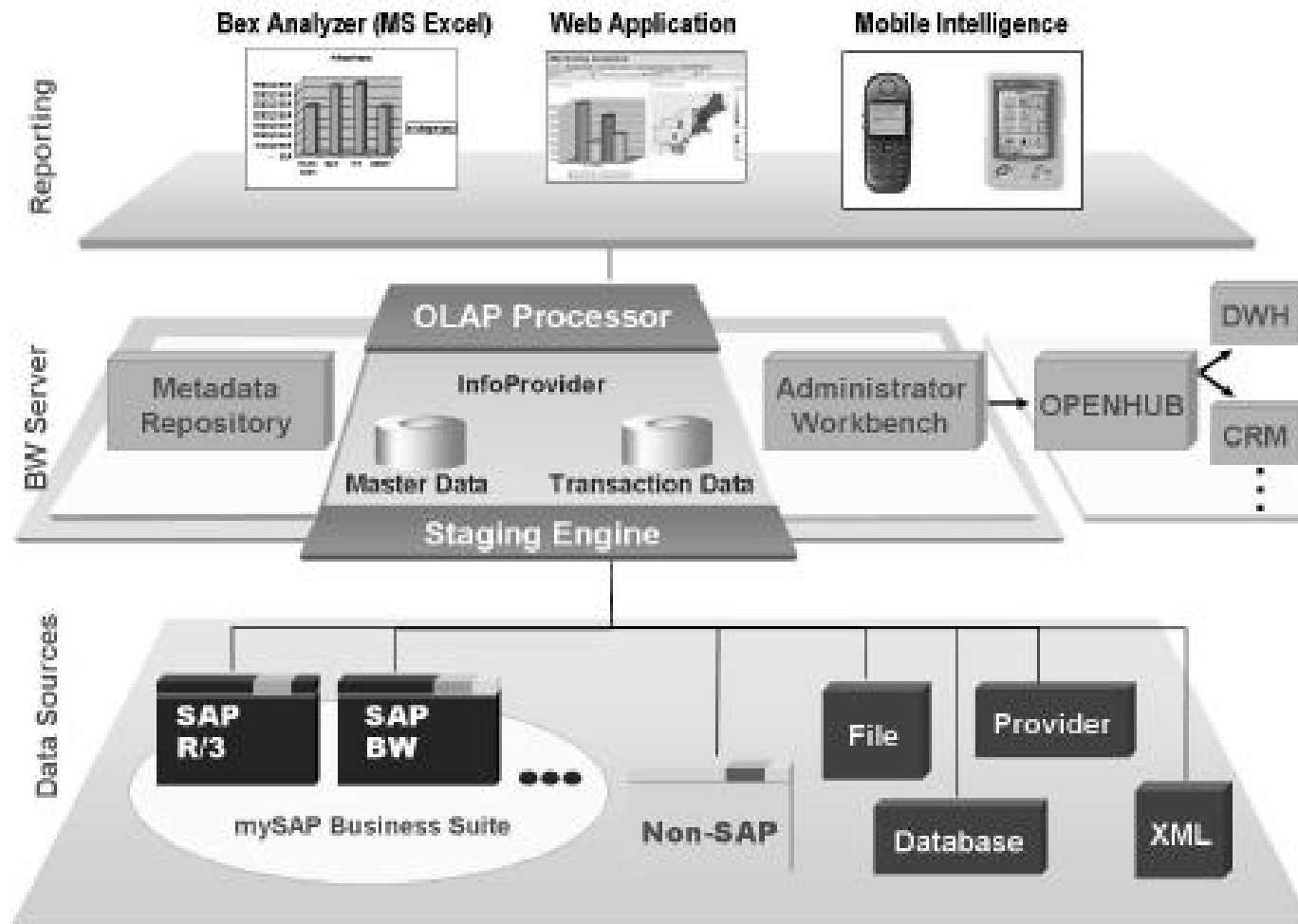
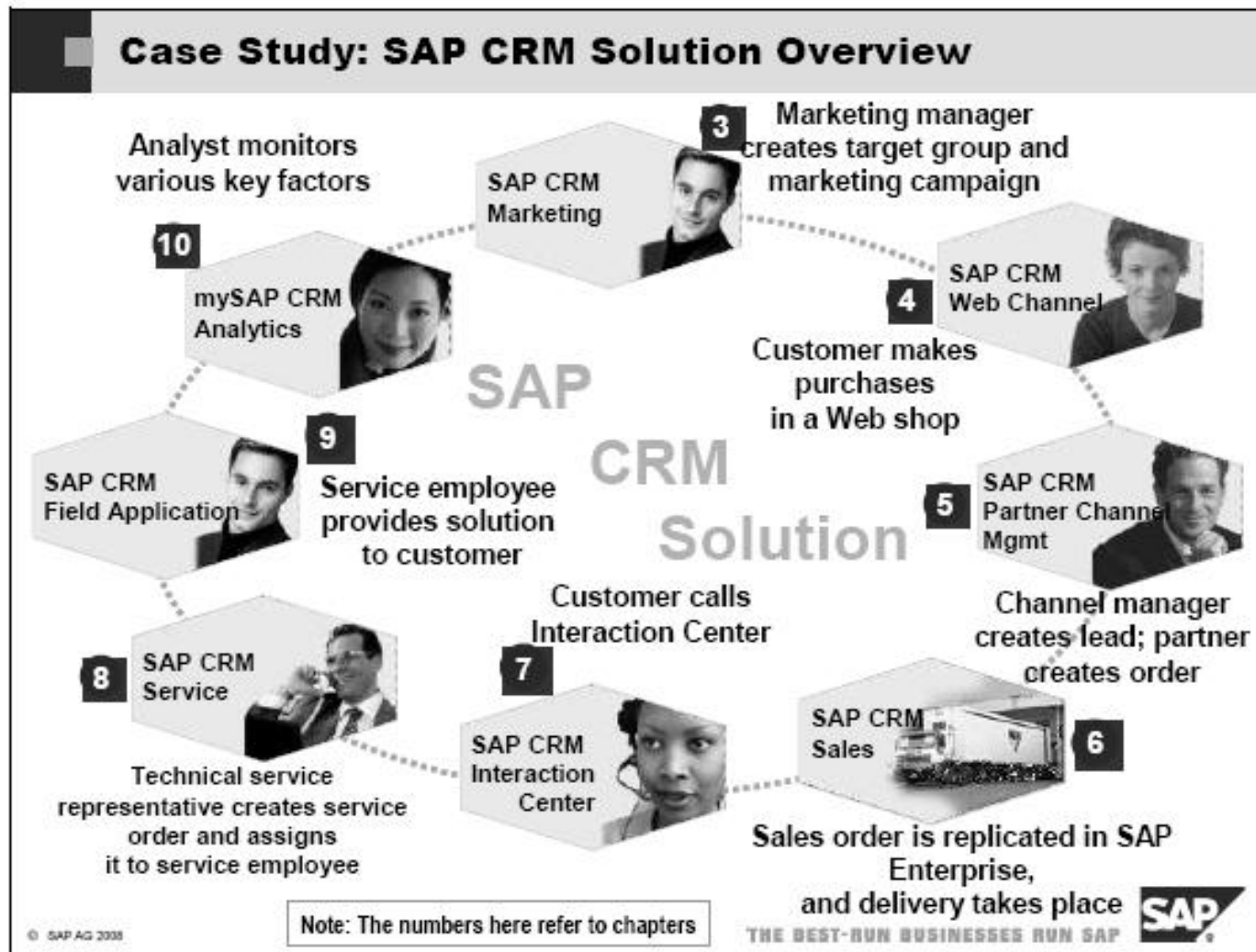
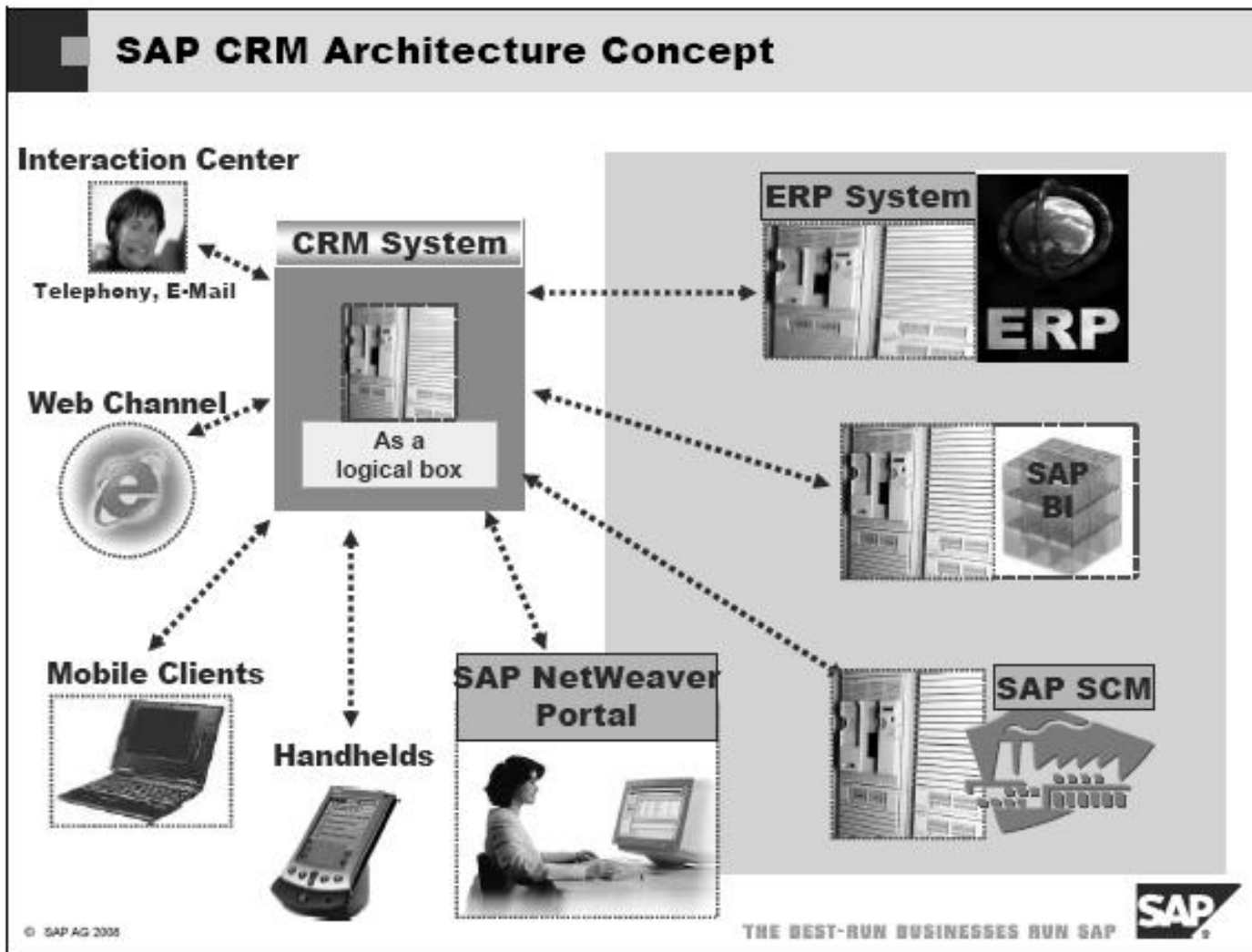
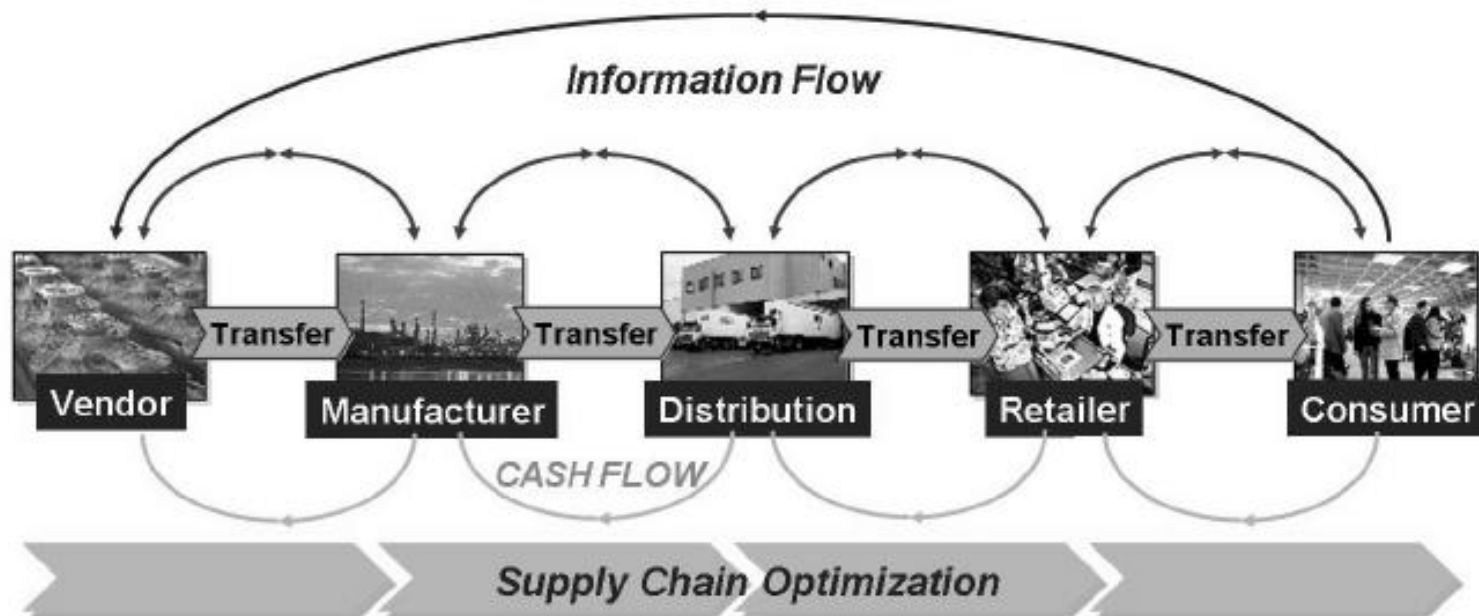

Figure 5: SAP BW Architecture







► Increase Customer Responsiveness at Least Cost

Figure 2: SAP Supply Chain Management: Supply Chain Optimization

Supply chain management manages the flow of material, information, and capital through a network of suppliers, manufacturers, distributors, and customers.

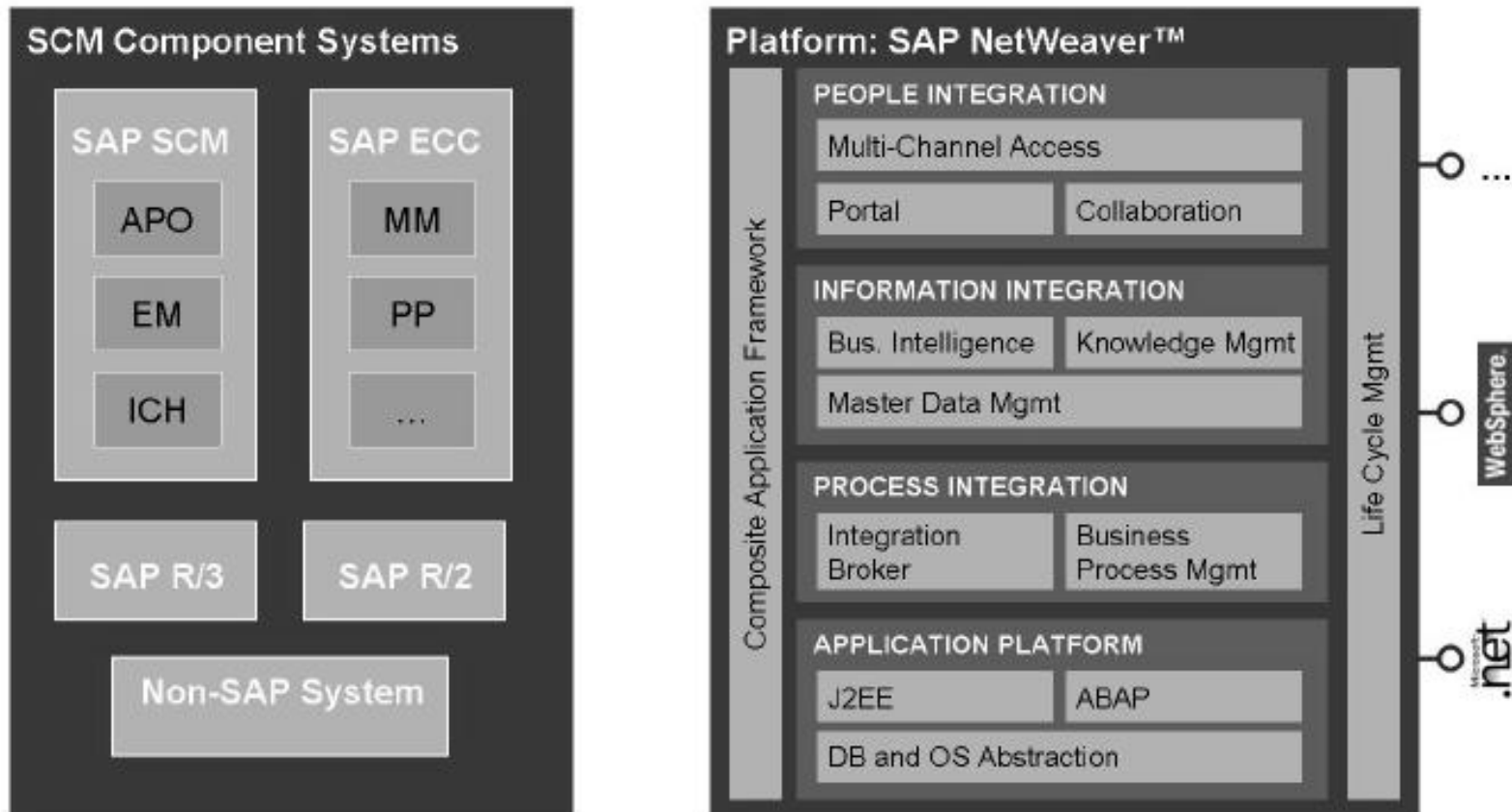
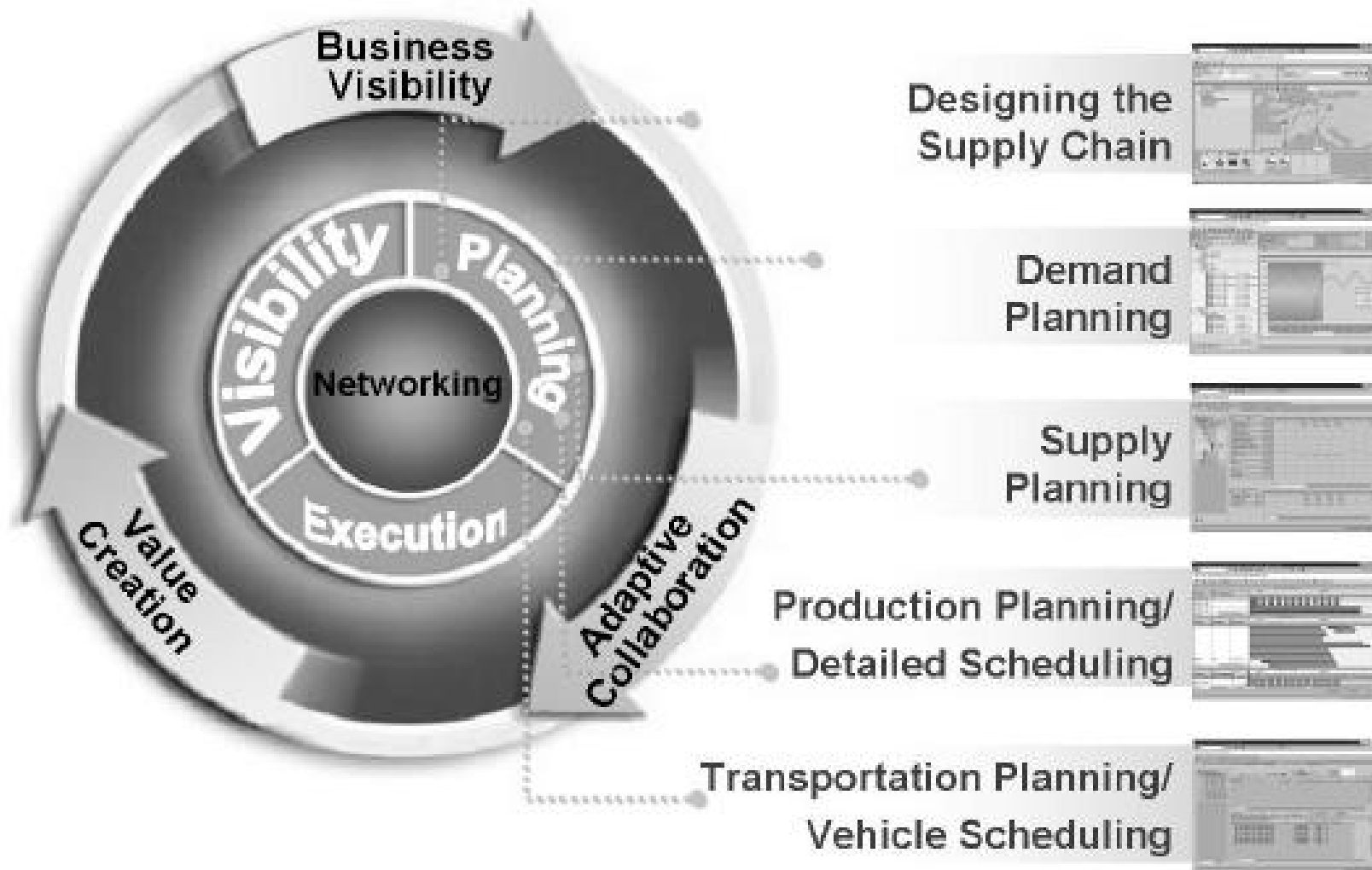
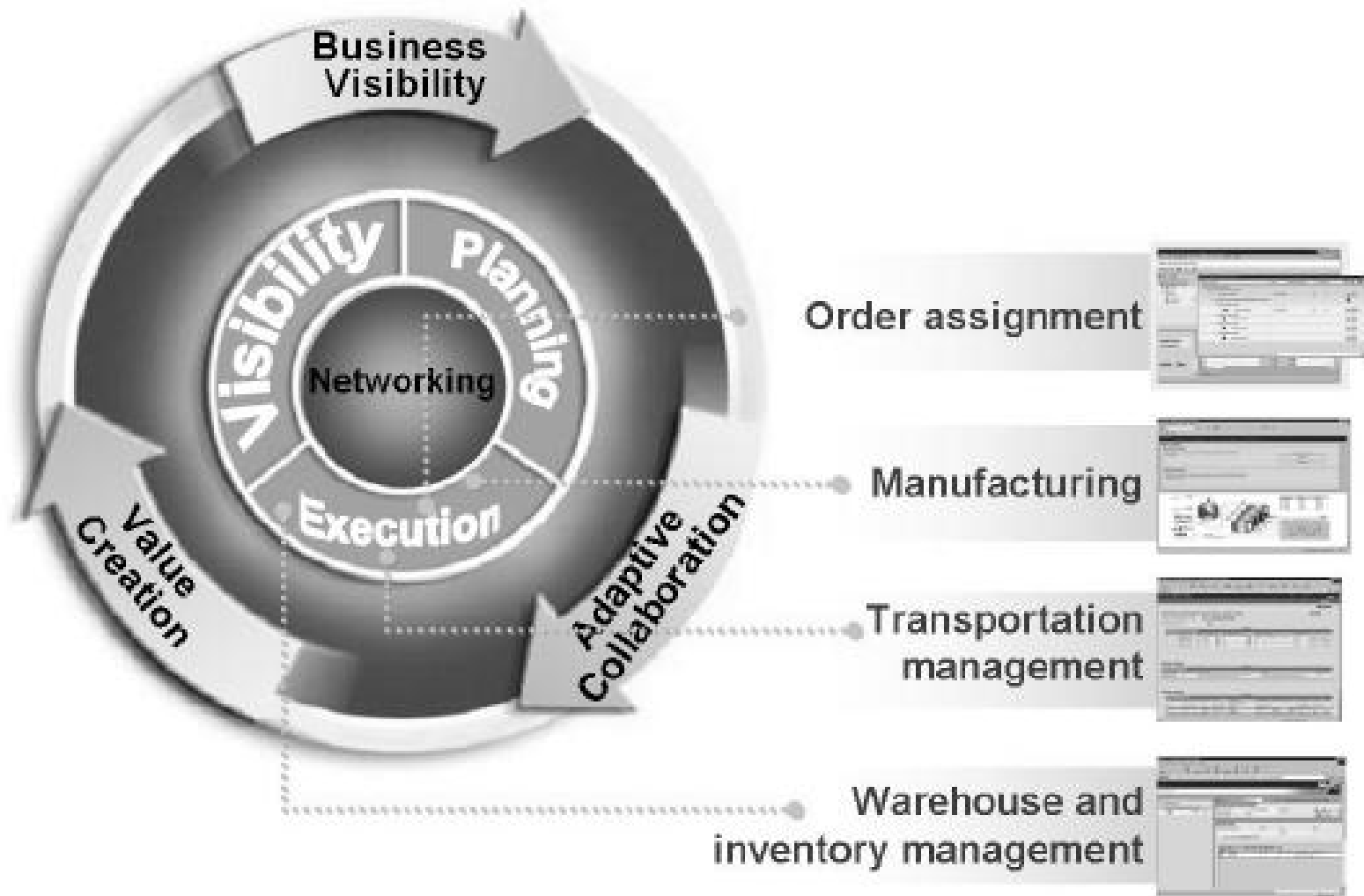
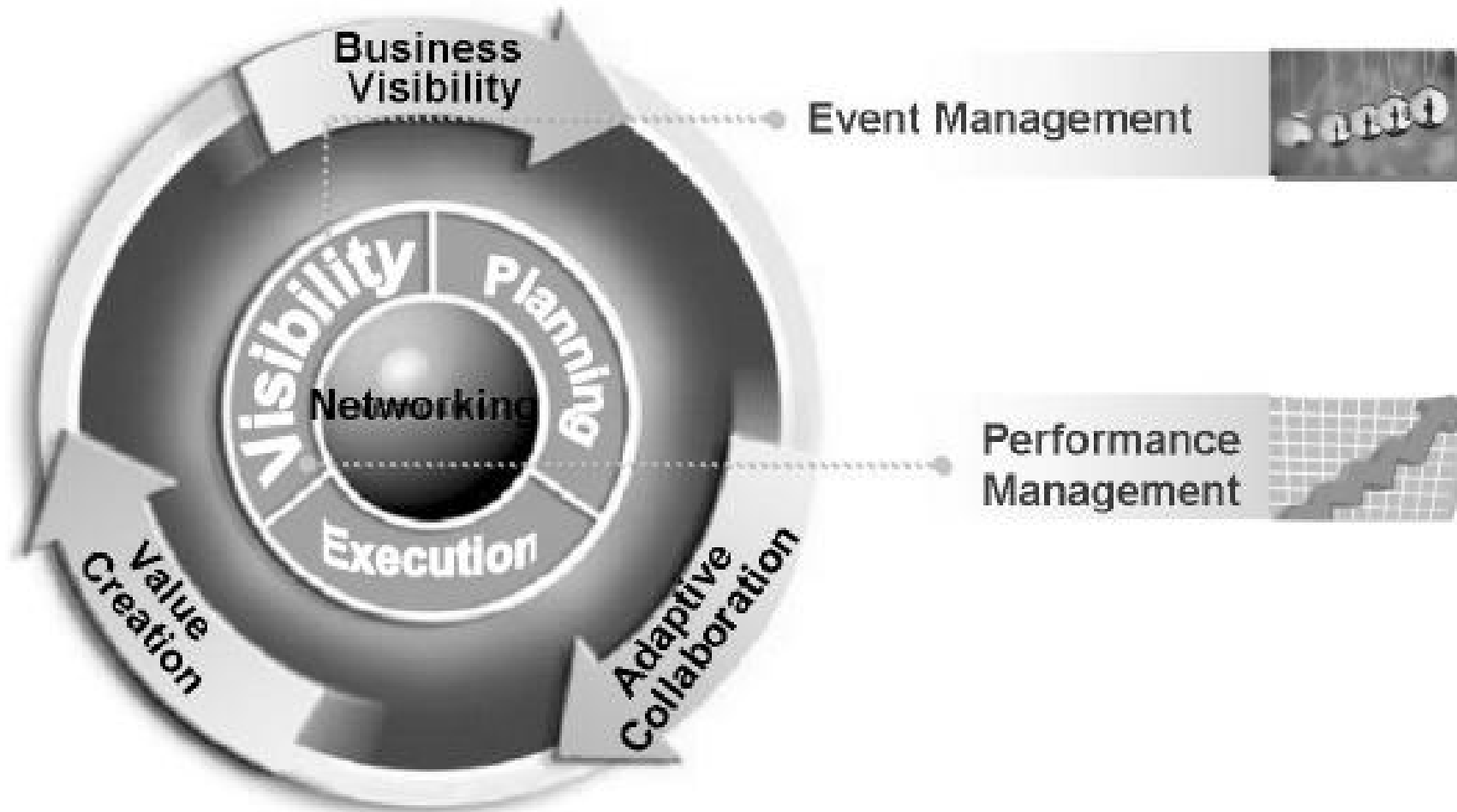

Figure 4: SAP SCM: Platform and Component Systems









SAP Procurement Portfolio



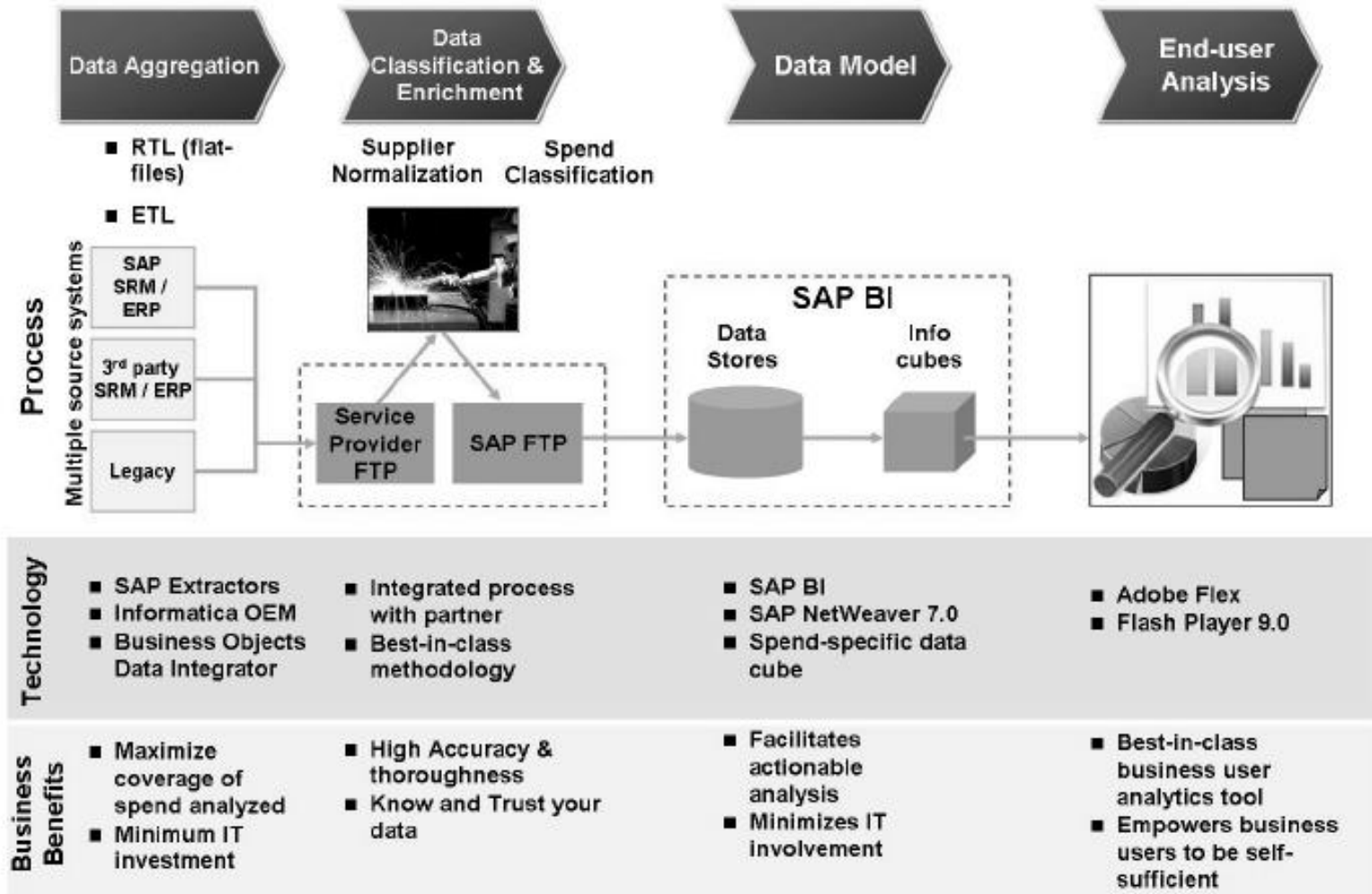
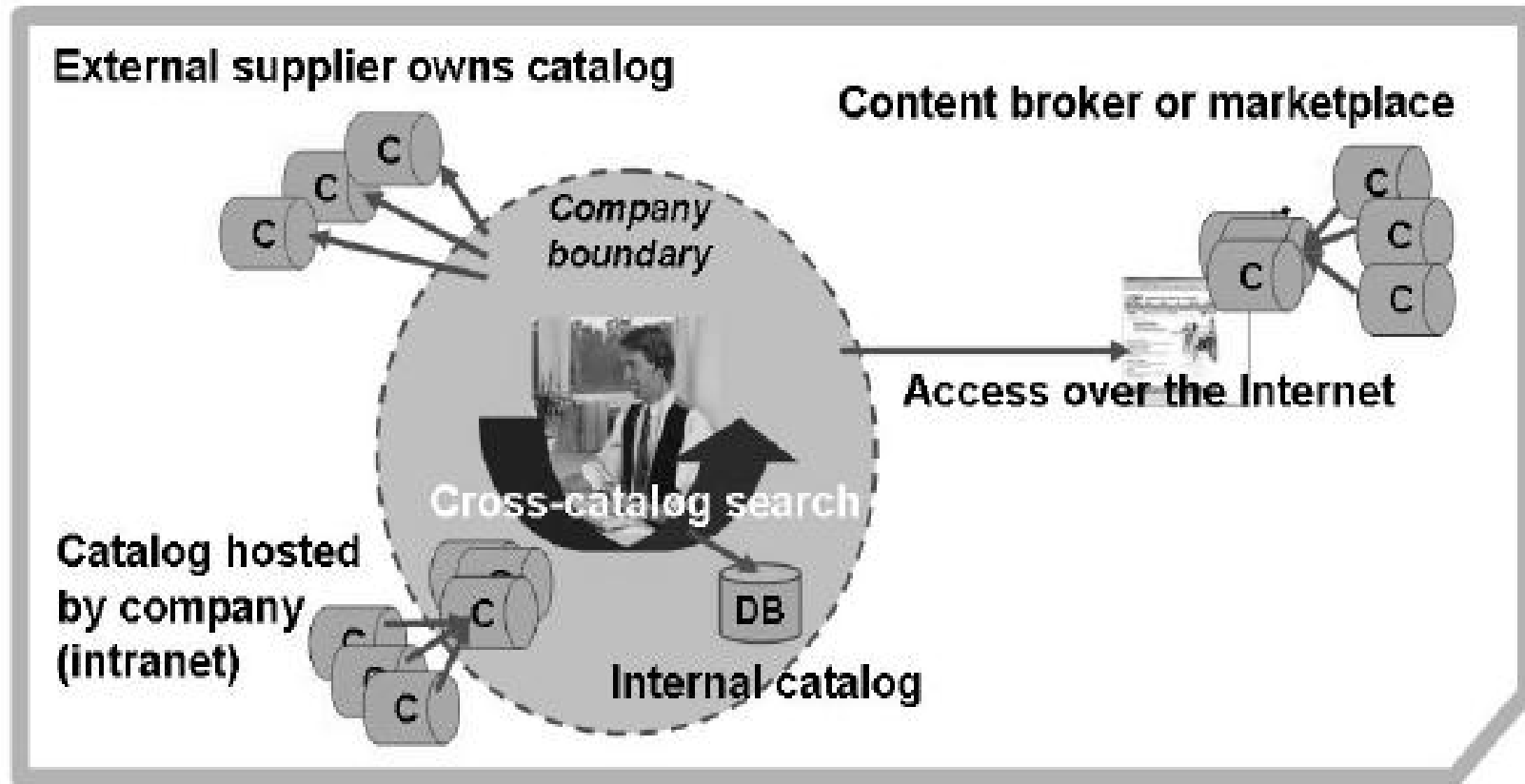

Figure 35: SAP Spend Analytics Process





SRM - Enterprise Buyer - Microsoft Internet Explorer provided by SAP IT

mySAP SRM Home | Help | Settings | Log off

Shop in 3 Steps

1 Select Goods/Service 2 **Shopping Cart (1 Item)** 3 Complete and Order

In this step, you can display and check your shopping cart containing the goods /services that you have selected. You can add further items to your shopping cart in step 1 or order the shopping cart in step 3.

Step 2: Shopping Cart

To change item details (assets and cost assignment), select the link below or select

Good / Service	Description	Category	Required on	Quantity	Price / Unit	
100-100	Casing	Metal processing	05.05.2004	1 PC	110,99 USD	
Total Value (Excluding Tax) :					110,99 USD	
Tax Amount :					0,00 USD	
Total Value :					110,99 USD	

Item Details: Casing

Basic Data

You can change the basic data. Changes are transferred automatically.

Description: Casing

Product ID: 100-100 Order as Direct Material

Product Category: Metal processing

Company Code: EES US INC

Location: Atlanta

Storage Location: Warehouse 0001

Purchasing Group: PH1 FORP 010

Order Quantity: 1 piece(s)

Price: 110,99 American Dollar Per 1 piece(s)

SAP Netweaver Portal

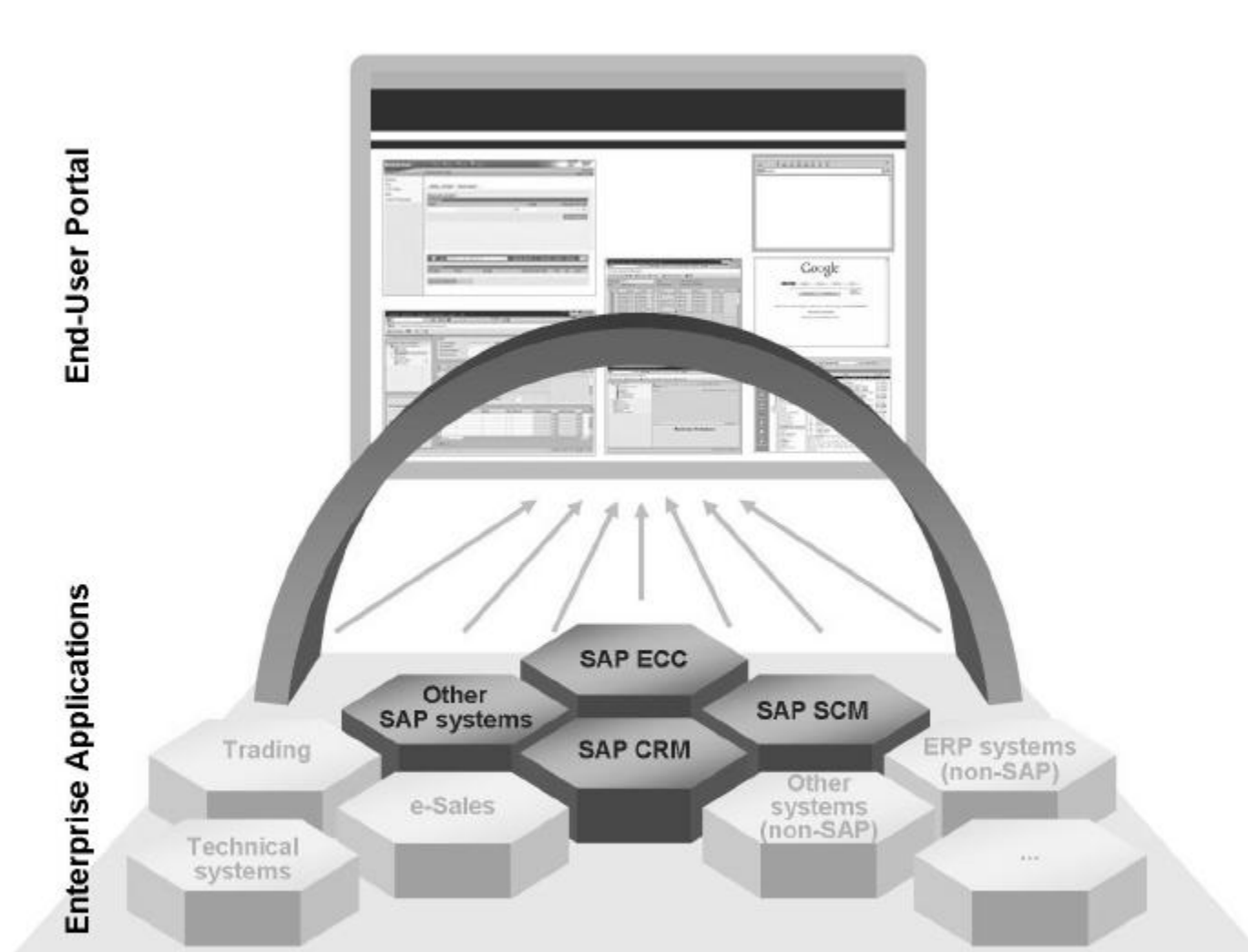

Figure 3: Advantages of a Portal: User and Role-Oriented “Webtops”

SAP NetWeaver Portal

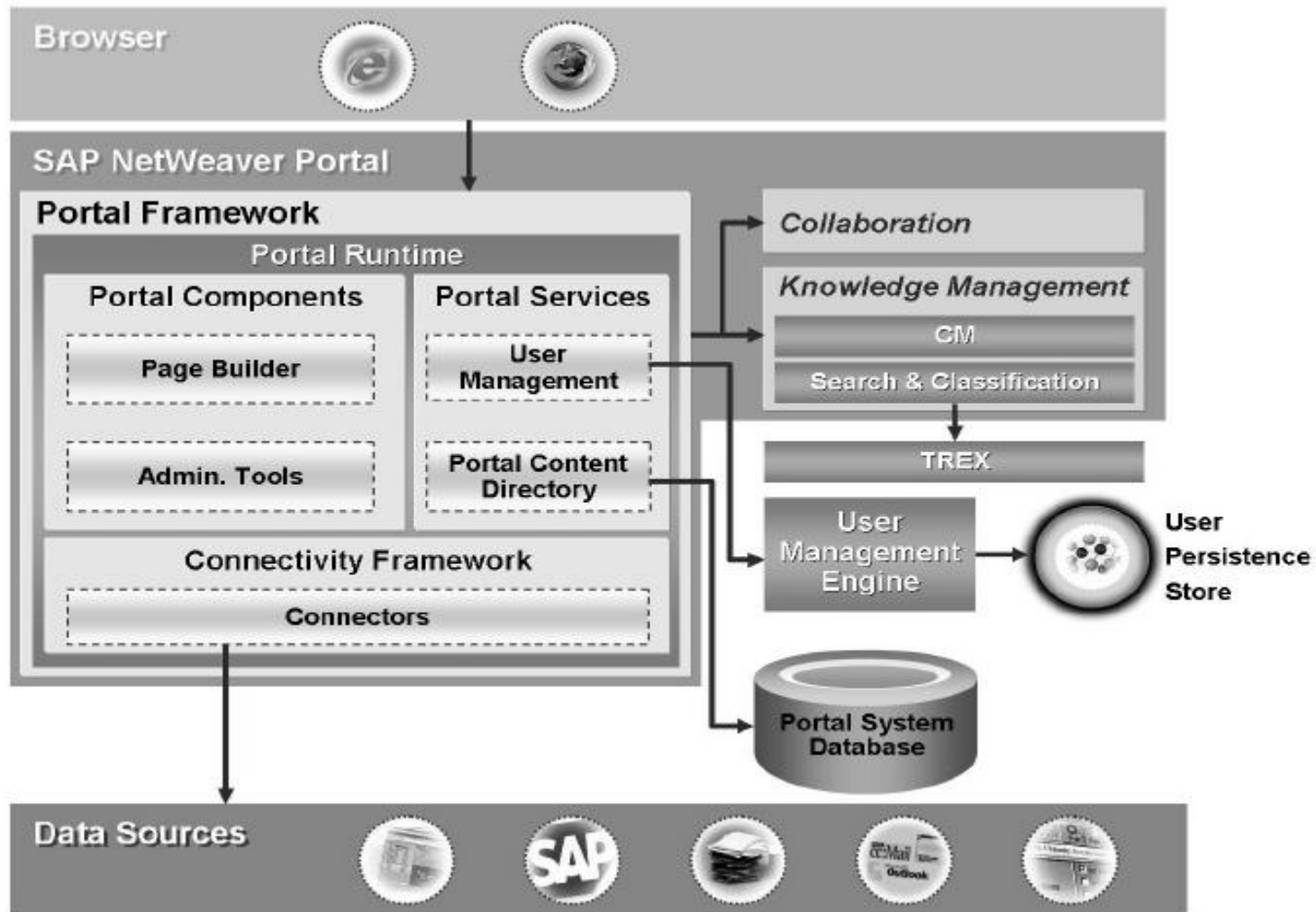
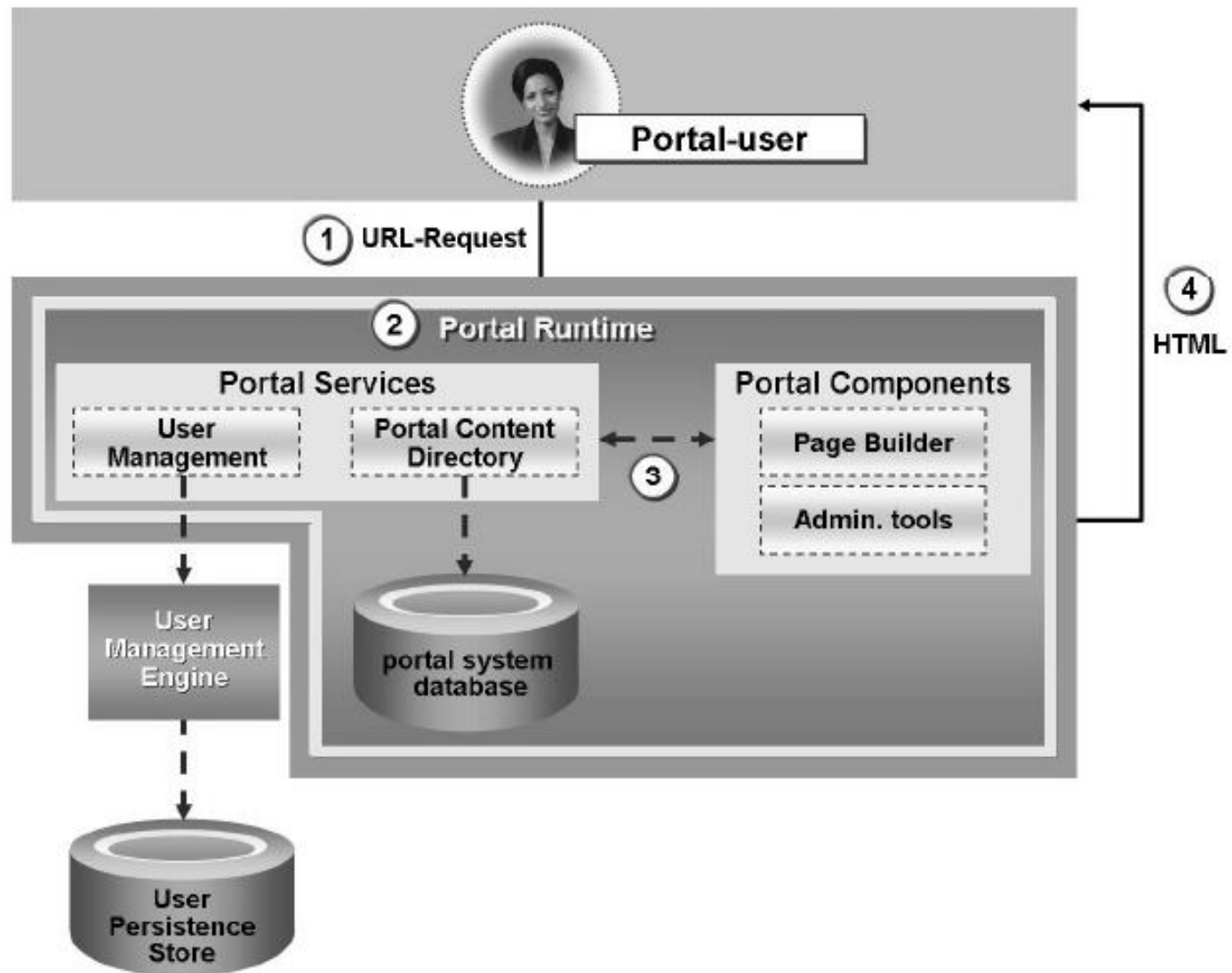

Figure 31: Software Architecture of SAP NetWeaver Portal

SAP Netweaver Portal



Content



Overview

Navigation Demo

The System Core

Main Products

Software Development, Deployment, and Lifecycle

Interfaces

System Administration

Learning and Job Market

Q & A

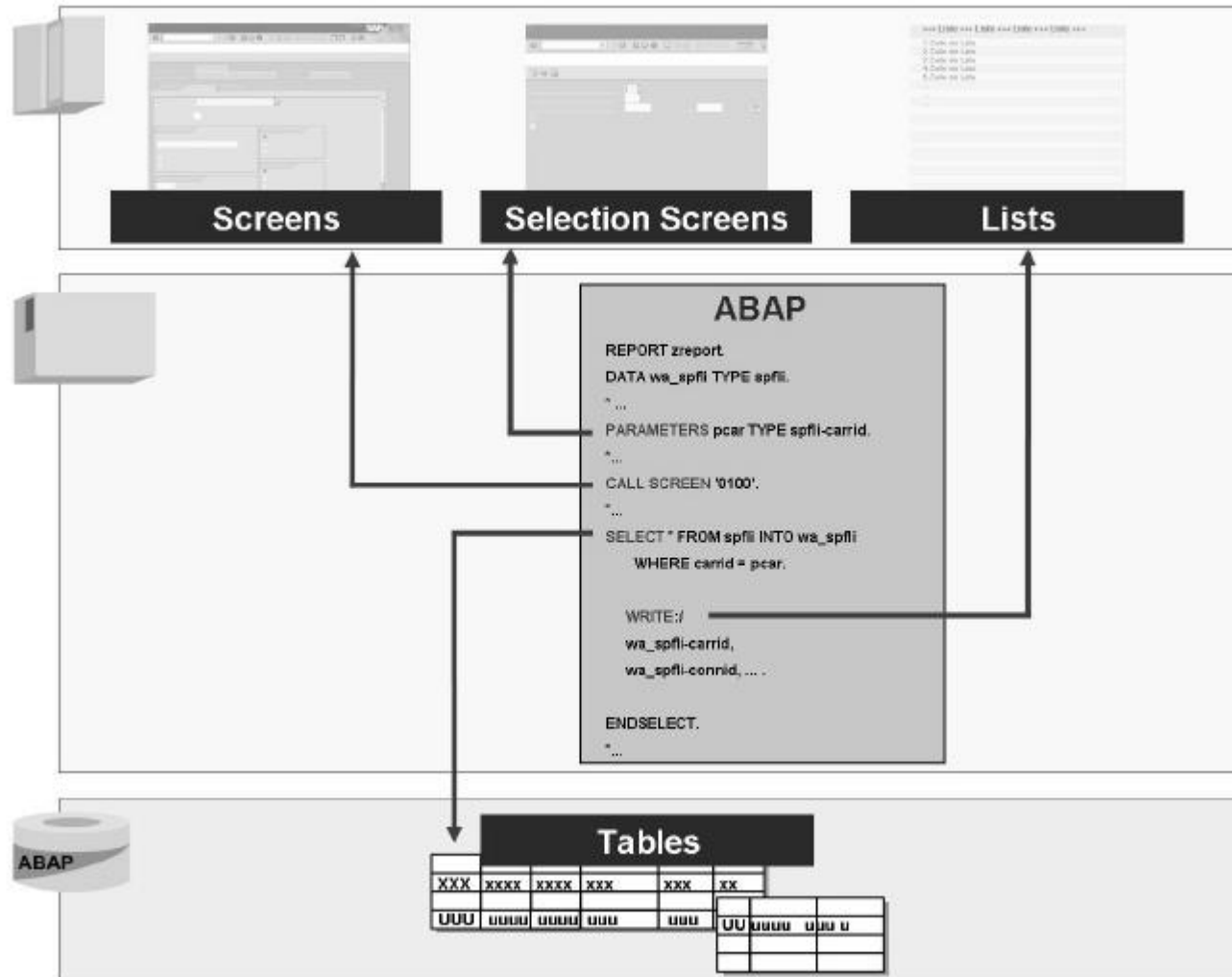

Figure 59: The ABAP Language

SAP Software Development

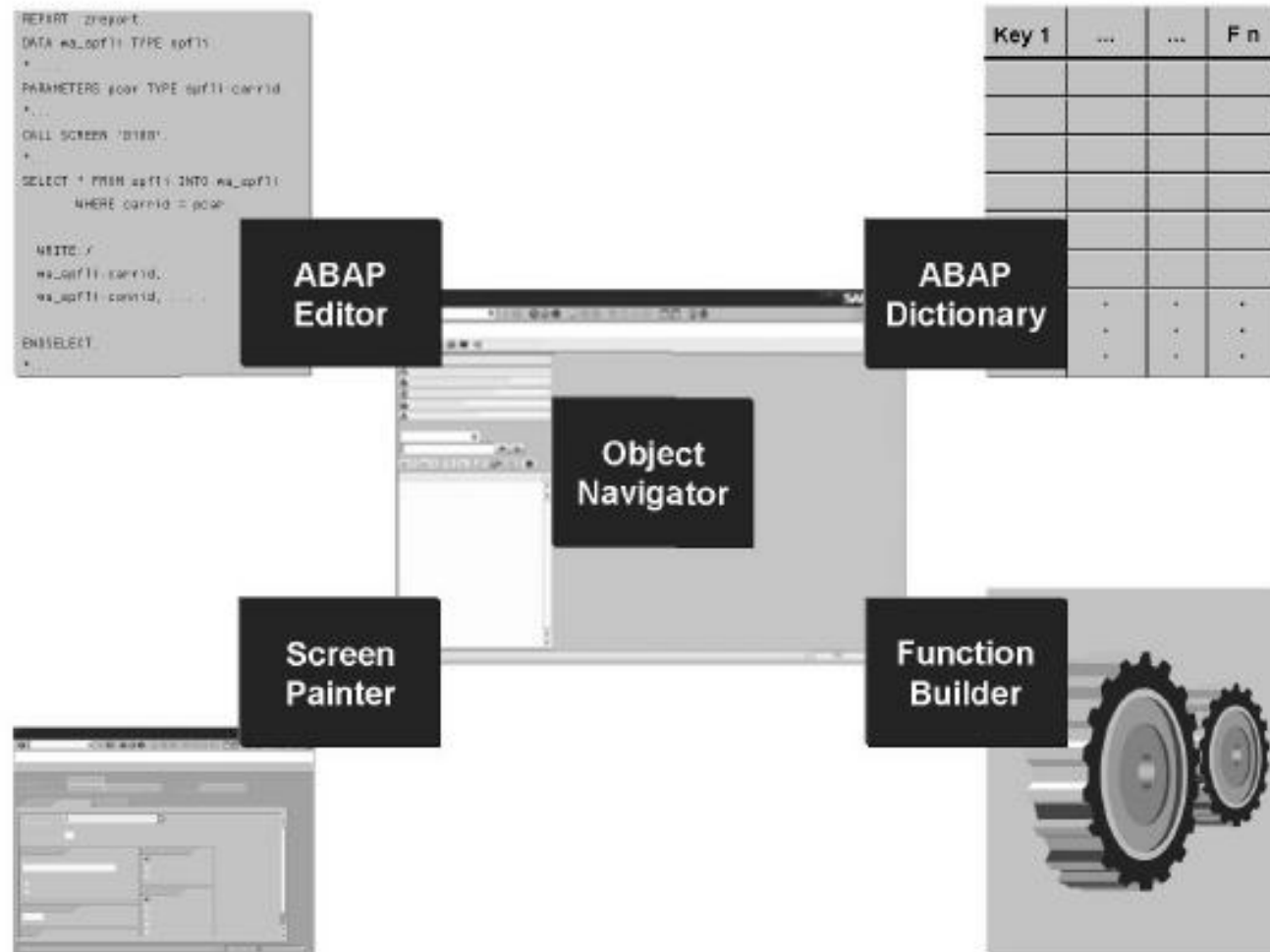
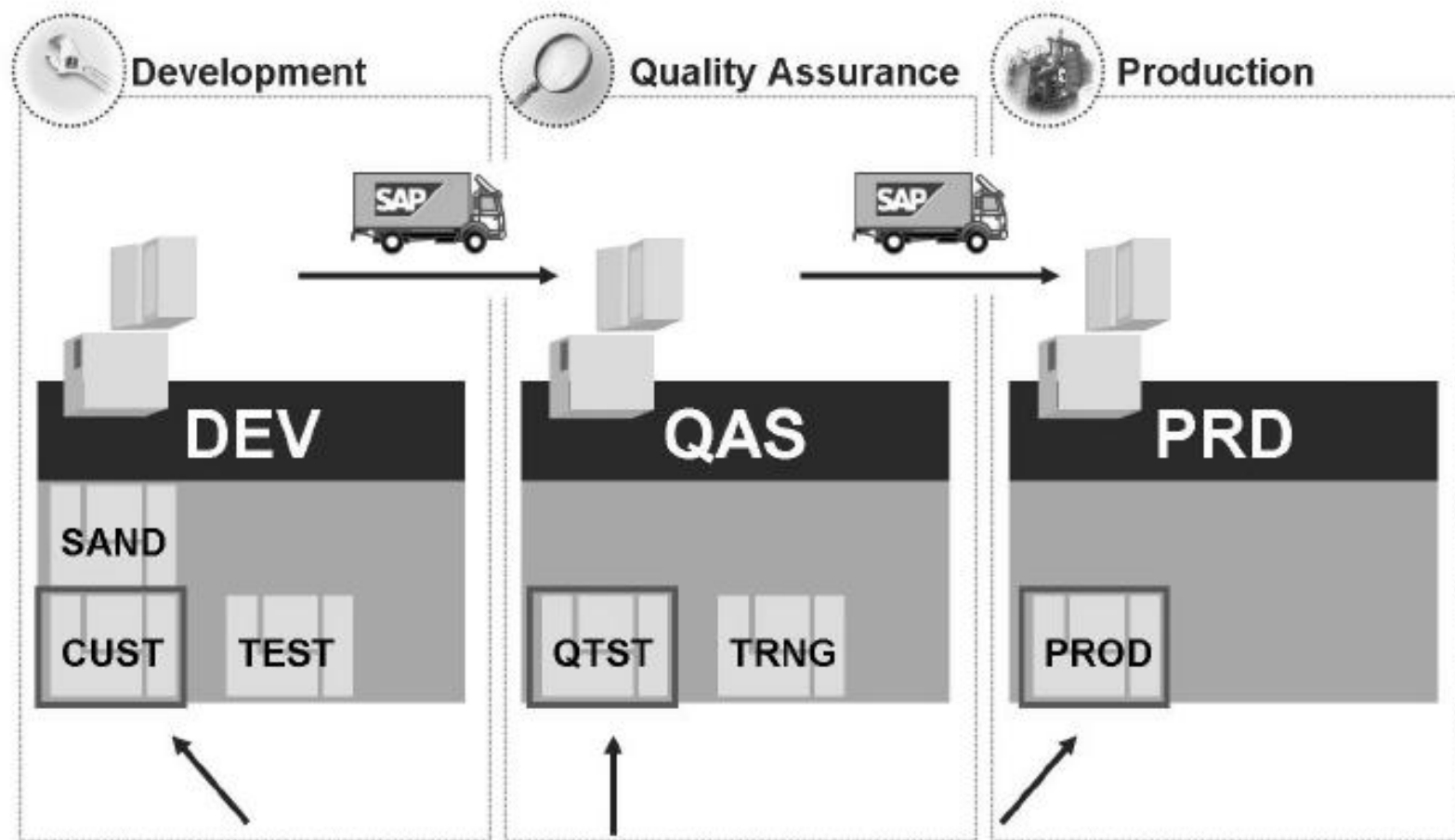

Figure 61: Some ABAP Workbench tools

SAP Software Development



3 working clients with the same identification, for example, 100

Figure 55: Three System Landscape in the ABAP Environment

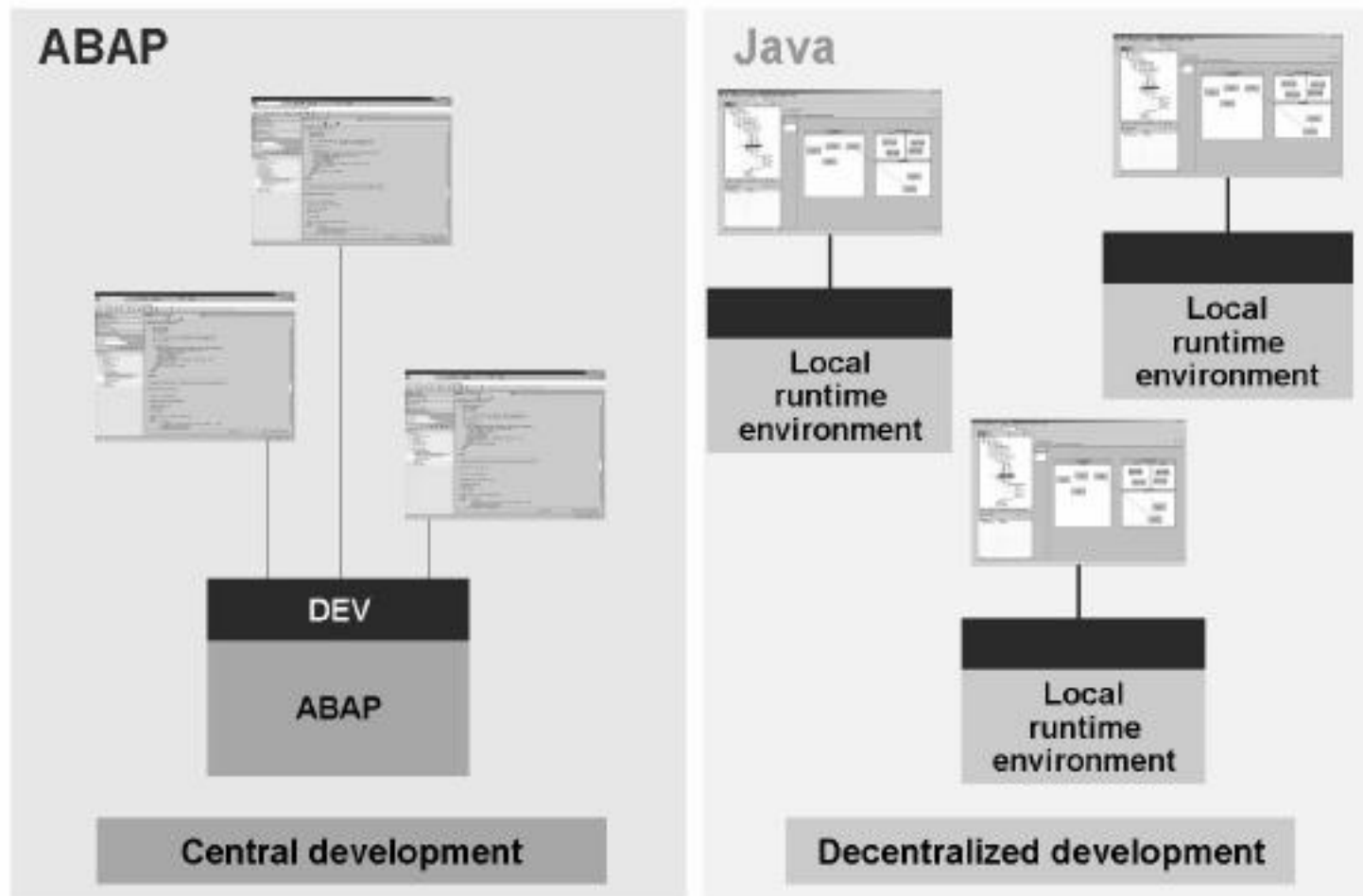

Figure 69: Different development philosophies

SAP Software Development

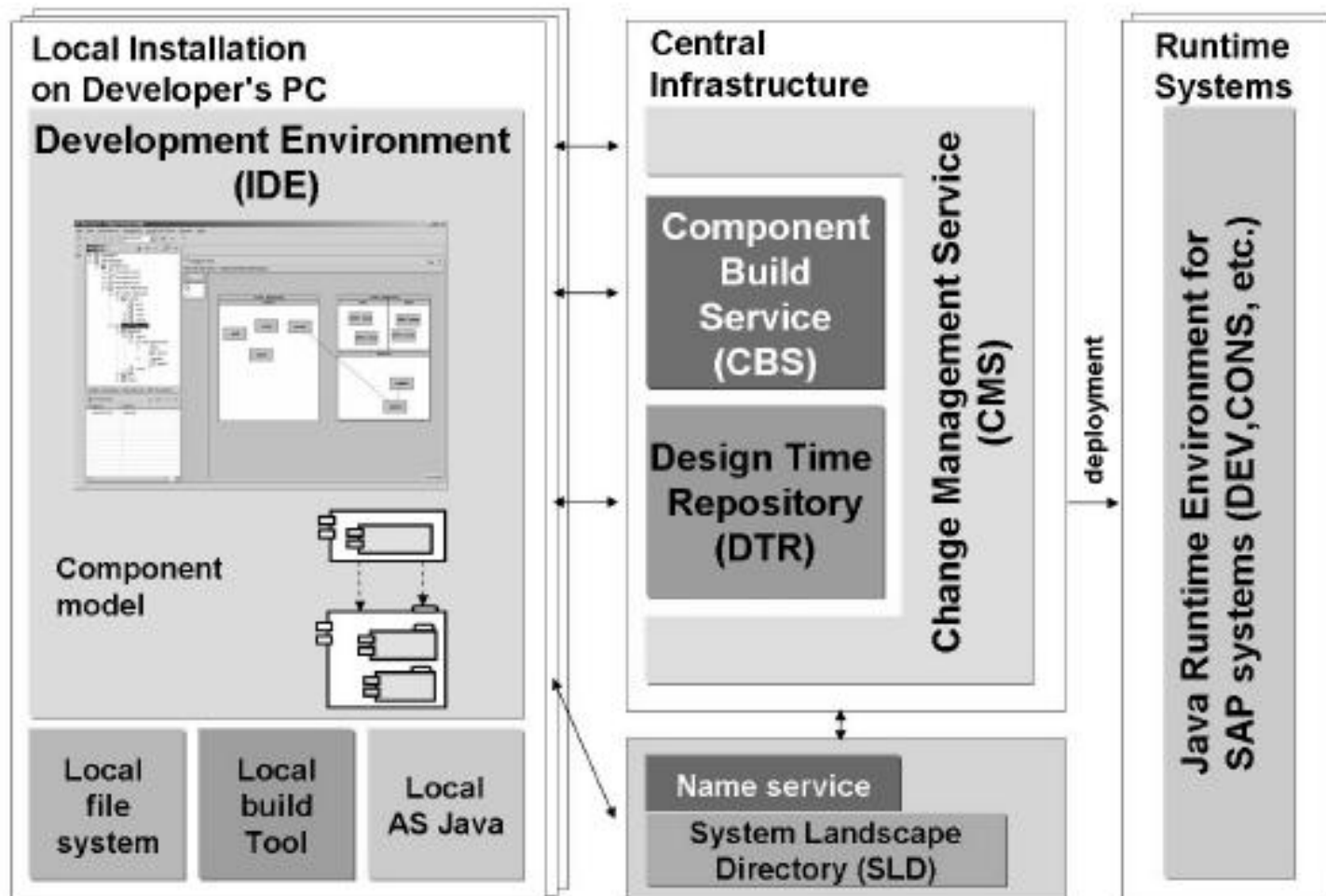
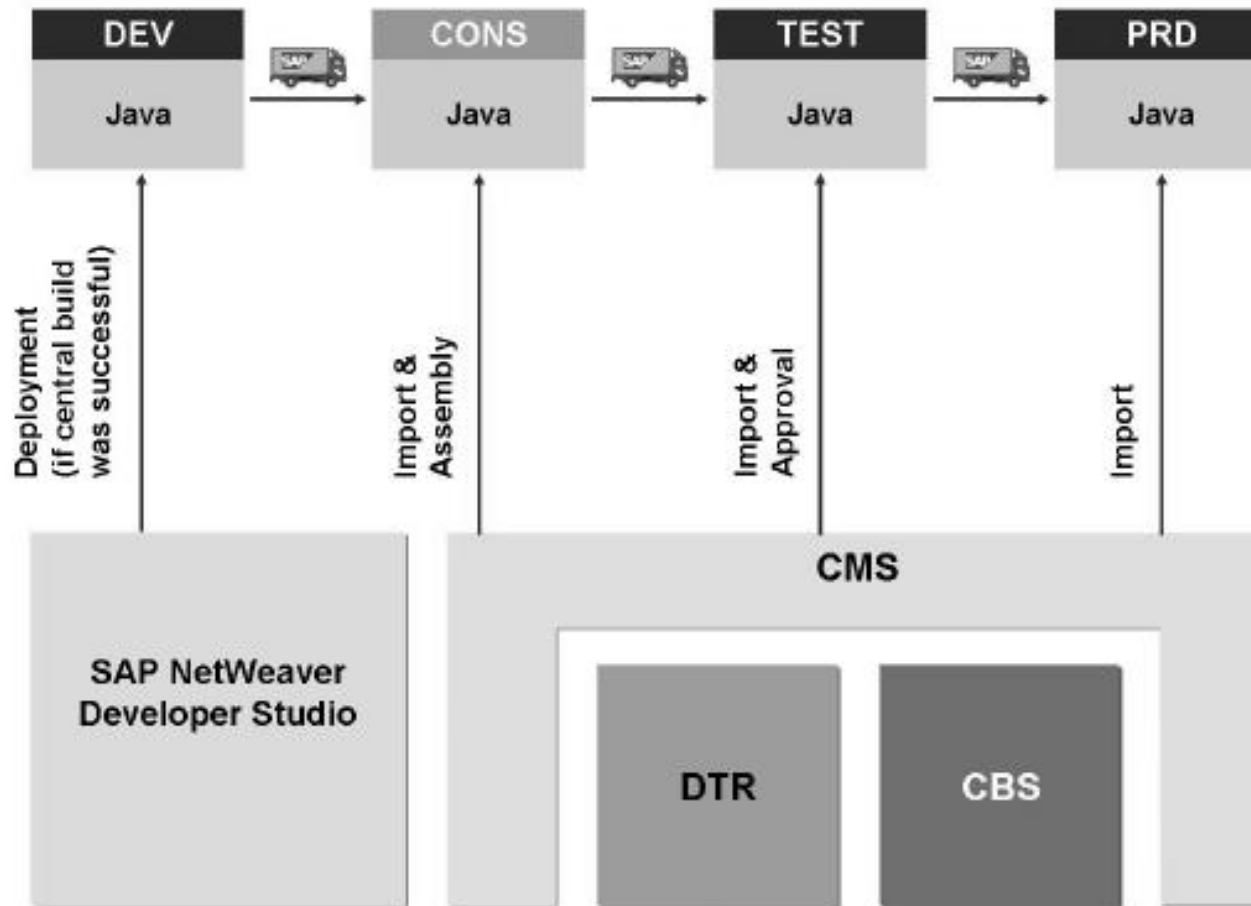

Figure 72: Overview of the SAP NetWeaver Development Infrastructure

SAP Software Development



Arrows show from which tool the data transfer was started.

Figure 74: Digression: The Four-Stage Landscape for Java Developments

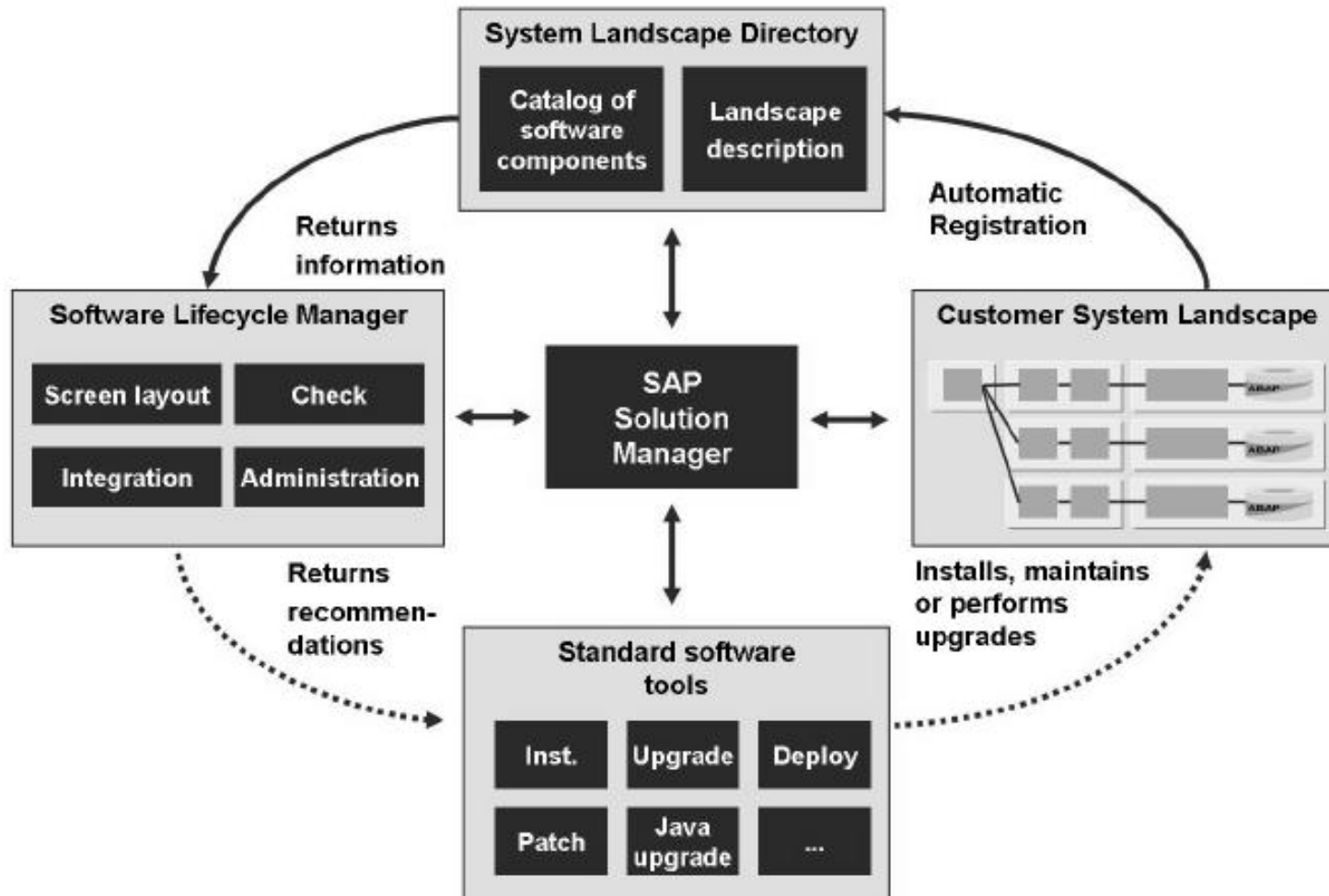

Figure 78: Software Lifecycle Management for SAP Systems: Overview



- **SAP Notes can contain error corrections.**
- **The SAP Note Assistant can often import these error corrections automatically.**

SAP Note Assistant (SNOTE)

Problem

- **Look for SAP Notes**
- **Read text of SAP Note**

- **Check prerequisites**
- **Implement SAP Note**
- **Register SAP Note**

SAP system



SAP Service Marketplace
<http://service.sap.com/notes>



Maintenance

NEW: Enhancement Packages

- New and improved functions
- Optional
- Technical: collection of new software components (versions)

Support Package stack

- Legal changes/changes to tax, program corrections
- Obligatory
- Technical: collection of Support Packages and patches

SAP Software Development



Powerful tools and sophisticated procedures for upgrading SAP systems:

- **AS ABAP: SAPup**
- **AS Java: SAPJup**

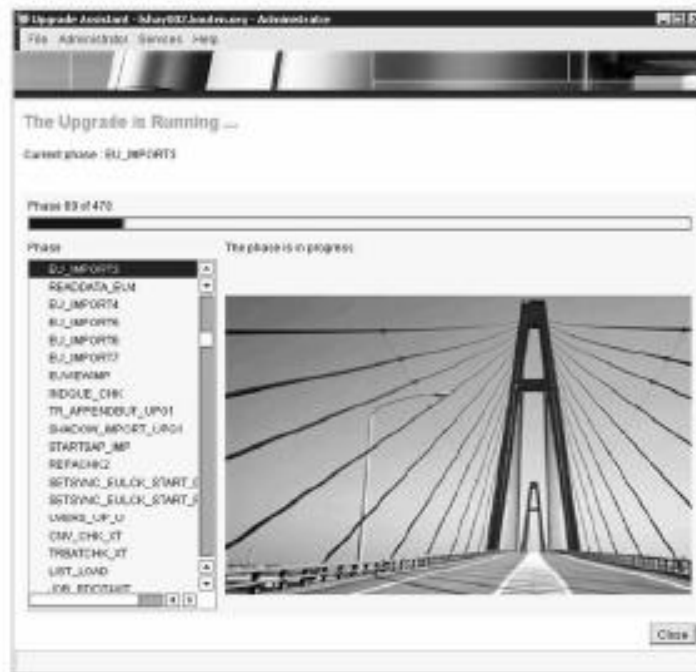

SAPup



SAPJup

Content



Overview

Navigation Demo

The System Core

Main Products

Software Development, Deployment, and Lifecycle

Interfaces

System Administration

Learning and Job Market

Q & A

Interfaces

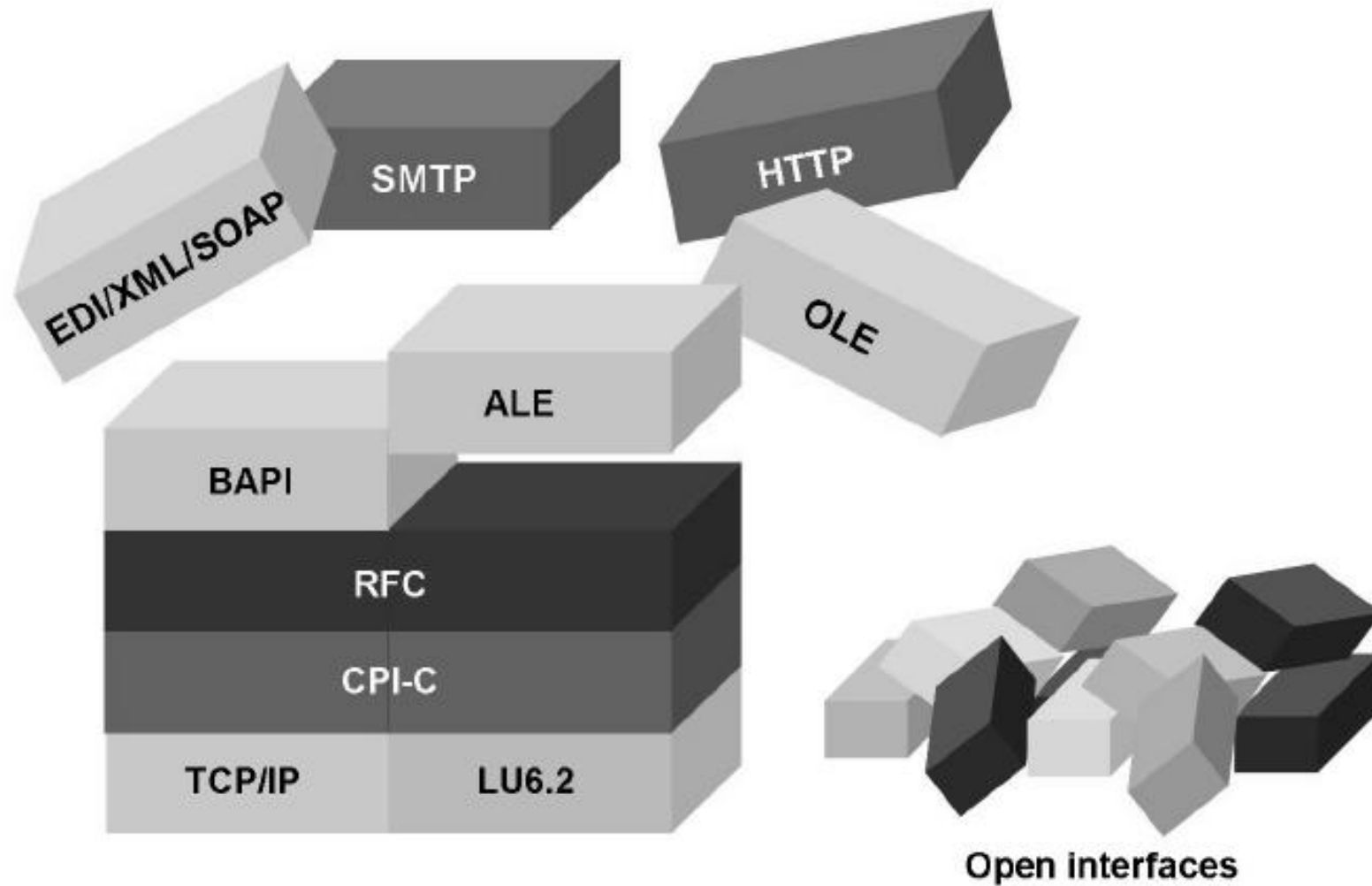

Figure 98: Interfaces technologies used in SAP systems

Interfaces

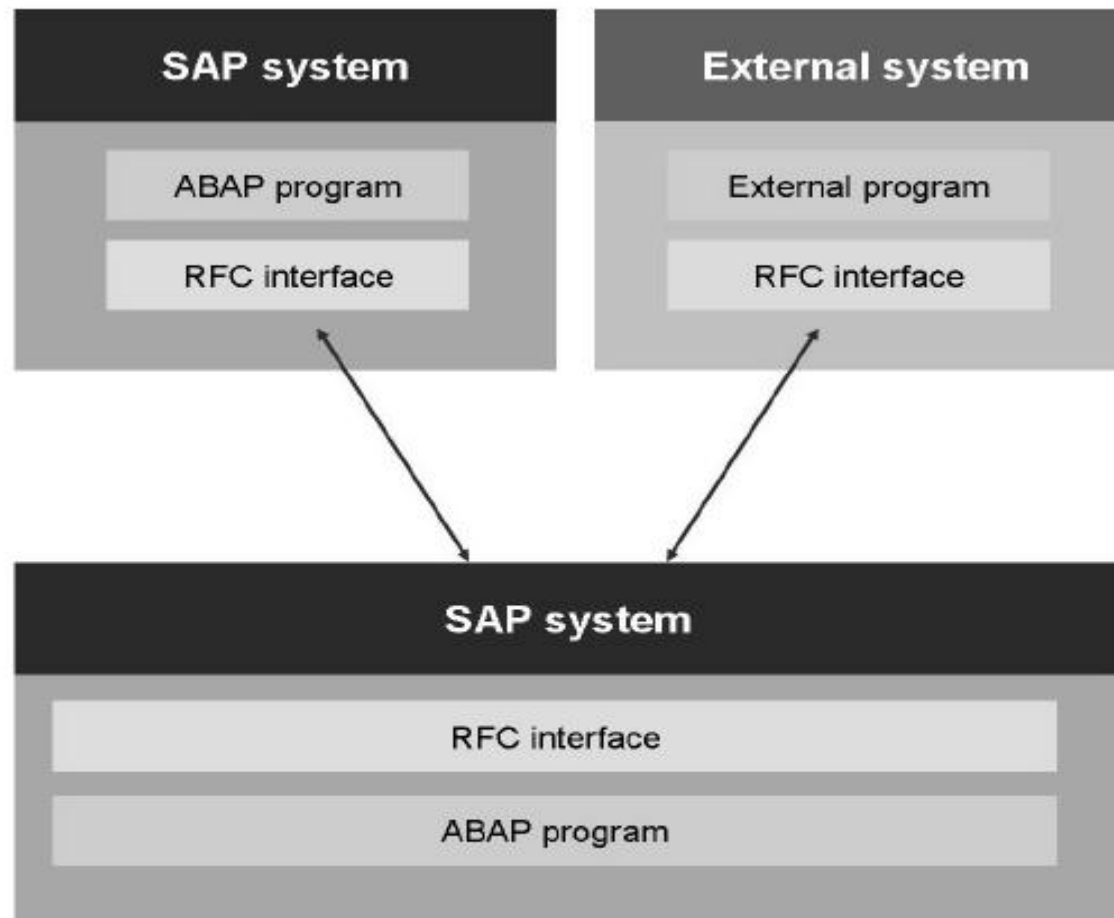

Figure 99: RFC connection possibilities

Content



Overview

Navigation Demo

The System Core

Main Products

Software Development, Deployment, and Lifecycle

Interfaces

System Administration

Learning and Job Market

Q & A

System Administration

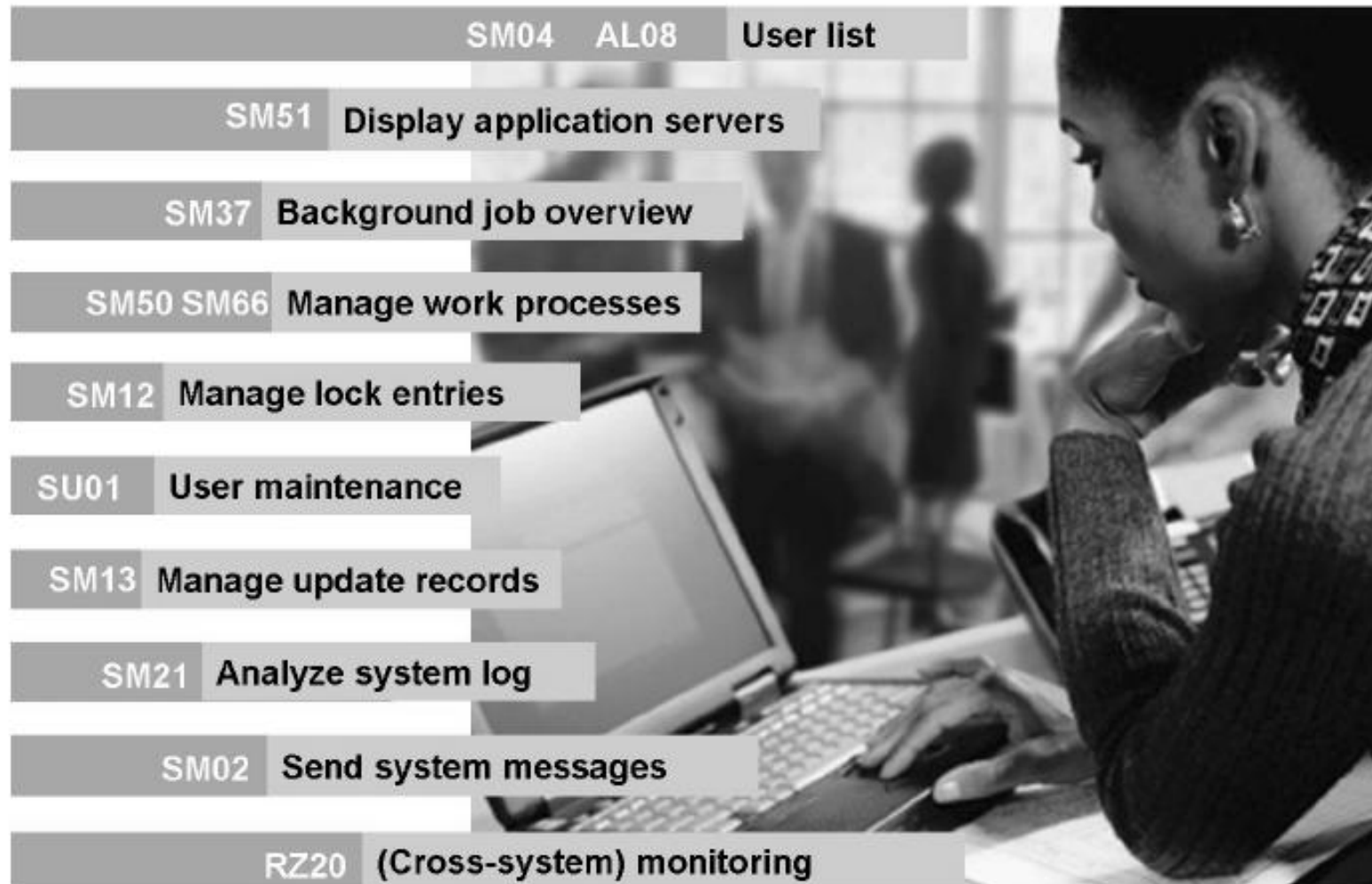



Figure 108: Important System Administration Transactions for the AS ABAP

System Administration



■ **SAP NetWeaver Administrator**



■ **UME Console**



System	Sub-System	Status
...

■ **Visual Administrator***



■ **Config Tool***



* Tools for experts

Figure 109: Tools for AS Java Administration

System Administration



Implementation of SAP solutions

- SAP methods & tools
- Global rollout
- Customizing sync.
- E-learning mgmt.
- Test management

Upgrade of SAP solutions

- SAP methods & tools
- E-learning mgmt.
- Test management

Change Request Management

- Follows ITIL standards
- Maintenance processes



Solution Monitoring

- System monitoring
- Business process monitoring
- Central system administration
- Solution reporting
- Service Level reporting
- SAP EarlyWatch Alert

Service Desk

- Best Practices for messaging
- Integration of 3rd-party help desks

Root Cause Analysis

- Safe remote access
- Performance measurement
- Logs and Dumps
- Traces
- Technical configuration

Delivery of SAP Services

- Onsite/remote delivery
- Issue Management

 = Required for the delivery of SAP Standard Support Services

Content



Overview

Navigation Demo

The System Core

Main Products

Software Development, Deployment, and Lifecycle

Interfaces

System Administration

Learning and Job Market

Q & A



SAP Classroom Training, Certificate, Demo

<http://www.sap.com/services/education>

Self Study

<http://www.sap-press.com/>



<http://sapcareers.com/>

<http://www.dice.com/>

<http://www.careerbuilder.com>

<http://hotjobs.yahoo.com/>

Content



Overview

Navigation Demo

The System Core

Main Products

Software Development, Deployment, and Lifecycle

Interfaces

System Administration

Learning and Job Market

Q & A

Questions?